

SHARP®

USER MANUAL

Before using the TV, please read this manual thoroughly and retain it for future reference.

ENGLISH

FRANÇAIS

ESPAÑOL

SHARP®

USER MANUAL

Before using the TV, please read this manual thoroughly and retain it for future reference.

Copyright Statement

© 2018 Hisense Company Ltd. All Rights Reserved.

All material in this User Manual is the property of Hisense Company Ltd. and its subsidiaries, and is protected under US and International copyright and/or other intellectual property laws. Reproduction or transmission of the materials, in whole or in part, in any manner, electronic, print, or otherwise, without the prior written consent of Hisense Company Ltd., is a violation of Hisense Company Ltd. rights under the aforementioned laws.

No part of this publication may be stored, reproduced, transmitted or distributed, in whole or in part, in any manner, electronic or otherwise, whether or not for a charge or other or no consideration, without the prior written permission of Hisense Company Ltd. Requests for permission to store, reproduce, transmit or distribute materials may be made in writing to the following address:

USA: Hisense USA Corporation
7310 McGinnis Ferry Road
Suwanee, GA 30024

CANADA: Hisense Canada Co., Ltd
2283 Argentia Road, Unit 16
Mississauga, ON, Canada L5N 5Z2

MEXICO: Hisense Mexico S. de R.L. de C.V.
Blvd. Miguel de Cervantes Saavedra No 301
Torre Norte Piso 2, Col. Ampliación Granada
Miguel Hidalgo, Ciudad de México, C.P. 11520

“Sharp™”, “Aquos™”, “Quattron™” and any and all other Sharp product names, logo’s, slogans or marks are registered trademarks owned exclusively by Sharp Corporation.

“Hisense™”, and any and all other Hisense product names, logo’s, slogans or marks are registered trademarks and intellectual property rights of Hisense Company Ltd. and its subsidiaries.

This product is sold to you under one or more license agreements between Sharp Corporation and Hisense International (Hong Kong) America Investment Co. Ltd. All other trademarks are the property of their respective holders.

Disclaimer Page

**Notwithstanding anything to the contrary, including in any or all descriptions, representations, statements or other communications related to this Sharp, Aquos or Quattron device (hereinafter "Device") made in any form whatsoever and at any time, some or all of the pre-installed, or subsequently installed Application Services may not be available or capable of functioning as intended by the provider of the Application Services in any or all usage areas for reasons outside of the control of the licensors or manufacturer of this device, including but not limited to, Internet access, local service limitations, etc. Any purchase or use of the Device, including any Application Services, is purely at the user's risk. Application Services are provided on an as-available basis without warranties of any kind, either expressed or implied, that the Application Service will be uninterrupted or error-free, including but not limited to vagaries of weather, disruption of Service, acts of God, warranties of title, local or regional limitations, no infringement, NOR IMPLIED WARRANTIES OF MERCHANTABILITY OR FITNESS FOR A PARTICULAR PURPOSE. No advice or information given by the licensors or manufacturers providers, affiliates, or contractors or their respective employees shall create such a warranty. All licensors and the manufacturer of this device, jointly and separately, specifically disclaim any and all responsibility for any or all Application Services from functioning at any time, and by purchasing the Device, you accept such disclaimer without any claim on the licensors and manufacturer. You are solely responsible for providing an active and working connection to the Internet, along with any and all hardware and/or software necessary to use the Device as intended.

Disclaimer:

Images throughout this document are for illustrative purposes only and may differ from the actual product.

Content

Content	3
Connecting Devices to your TV.....	4
Connecting an antenna, cable set-top box or satellite receiver	4
Connecting a satellite receiver, DVD player or other audio visual (AV) device with a composite video cable (yellow/red/white).....	4
Connecting an AV device with a component video cable (red/blue/green)	5
Connecting an AV device with an HDMI cable.....	5
Connecting a headphone	6
Connecting speakers or other audio receivers.....	6
Connecting a digital sound bar to use Audio Return Channel (ARC).....	7
Using Your TV Remote Control.....	8
Buttons on your TV remote.....	8
Remote control range information.....	8
Begin using your remote	9
Completing the First-Time Setup Menu	10
Shortcuts Instructions.....	12
Selecting the input source	12
Changing Channels / Volume	12
Shortcuts Instructions	12
Basic Settings	13
Using the Menu.....	13
Picture Menu	14
Audio Menu.....	15
Channels Menu	16
Accessibility Menu	16
Settings Menu	17
About TV Menu	19
Media.....	20
Digital Media player	20
Browse the Photos	21
Enjoy Music Files	21
Enjoy Movie Files	22
Quick Problem-Solving Tips	23

Connecting Devices to your TV

You have several options for connecting your TV to different devices. The method in which you connect will be based upon the type of cables you have and the available outputs on your device.

Connecting an antenna, cable set-top box or satellite receiver

To connect an antenna, cable set-top box or satellite receiver:

1. Connect one end of a coaxial cable (not included) to the **RF OUT** port on the antenna, cable or satellite box. If you are using an antenna with twin-lead cable, you may need a 300-75 Ohm adapter (not provided) to connect it to the back of your TV. Likewise, if you are using several antennas, you may need a combiner (not provided).
2. Connect the other end of the cable to the **ANT/CABLE IN** port on the side of TV.
3. Using your remote, press the **[INPUT]** button and select **TV** as the input source.

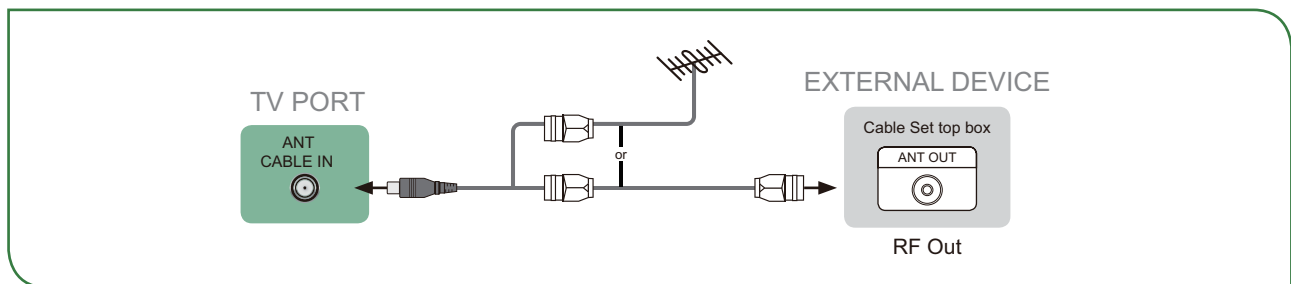

Connecting a satellite receiver, DVD player or other audio visual (AV) device with a composite video cable (yellow/red/white)

To connect an AV device with a composite video cable (not provided):

1. Use the audio and video cables to connect the composite video/audio ports of the external AV device to the **AV IN** ports of the TV. (Video = yellow, Audio Left = white, and Audio Right = red)
2. Plug the connected devices into the AV connectors on the TV before switching it on.
3. Using your remote, press the **[INPUT]** button and select **AV** as the input source.

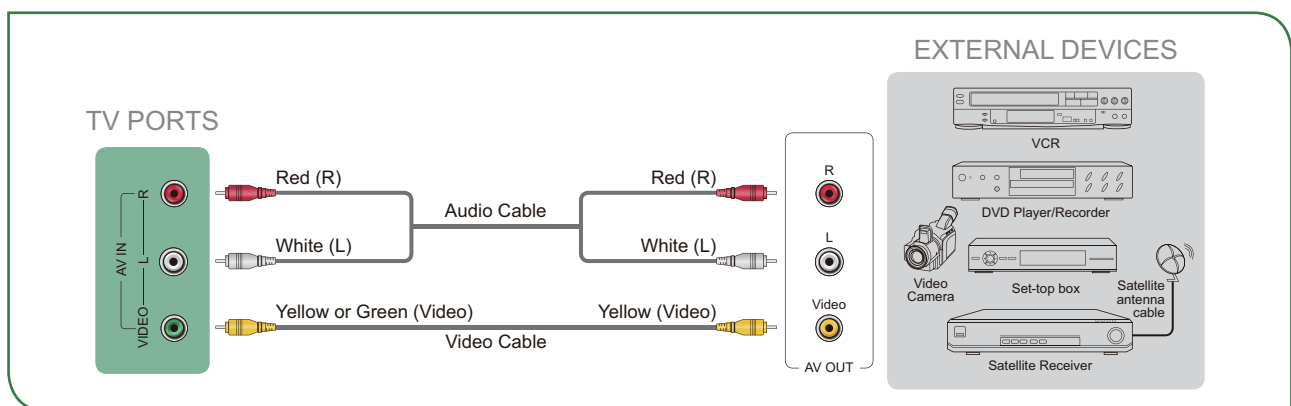

Connecting an AV device with a component video cable (red/blue/green)

To connect an AV device with a component cable (not provided):

1. Use a component video cable to connect the component output ports of the external device to the **Y P_B P_R** ports for the TV. (Y = green, P_B = blue, and P_R = red). Use an audio cable to connect the component audio ports of the external device to the TV **AUDIO (L/R)** ports.
2. Plug the connected devices into the **Y P_B P_R** and **L/R** ports on the TV before switching it on.
3. Using your remote, press the **[INPUT]** button and select **COMPONENT** as the input source.

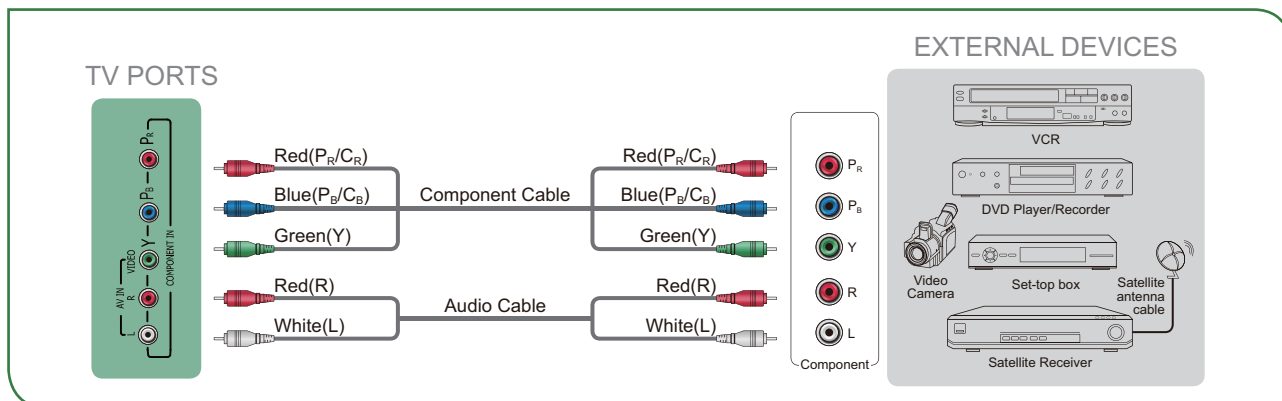

NOTE

- One AV device can be connected to the TV using a component video or composite video cable.

Connecting an AV device with an HDMI cable

This type of connection supports digital connections between HDMI-enabled AV devices such as a Personal Video Recorder (PVR), DVD, Blu-Ray, AV receiver and digital devices. In addition, some devices (such as a PVR or DVD player) require an HDMI signal to be set to Output in the settings of the device.

Please refer to the User Manual that came with your device for step-by-step instructions.

To connect an AV device with an HDMI cable (not provided):

1. Use an HDMI cable to connect the HDMI output port of the AV device to the **HDMI** port of the TV.
2. Plug the connected devices into the **HDMI** port on the TV before switching it on.
3. Using your remote, press the **[INPUT]** button and select the corresponding **HDMI** input.

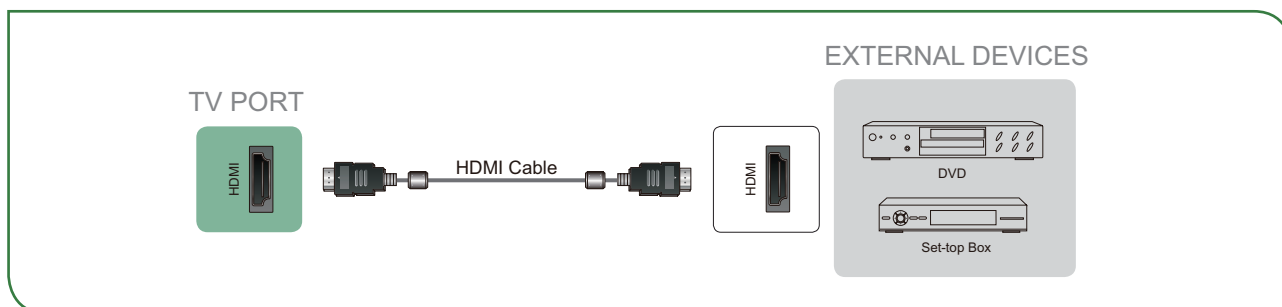

NOTES

- Because the HDMI connector provides video and audio signals, it is not necessary to connect an audio cable.
- We strongly recommend to use HDMI Cable with 2 cores as shown in the figure.

Connecting a headphone

You can connect headphone (not provided) to the **AUDIO OUT** port on your TV. While the headphone is connected, the sound from the built-in speakers will be disabled.

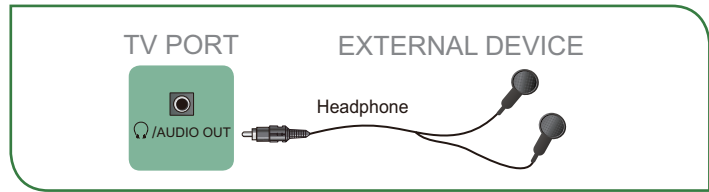

Connecting speakers or other audio receivers

To connect speakers or other audio receivers with an audio cable (not provided):

1. Use an audio cable to connect the digital audio in port of the audio receiver device to the **DIGITAL AUDIO OUT** port of the TV. Another option is to use an RCA Y-cable (1/8"-stereo mini to L/R phono) to connect an analog sound system to the **AUDIO OUT** port of the TV.
2. Plug the connected devices into the main power socket before switching on the TV.

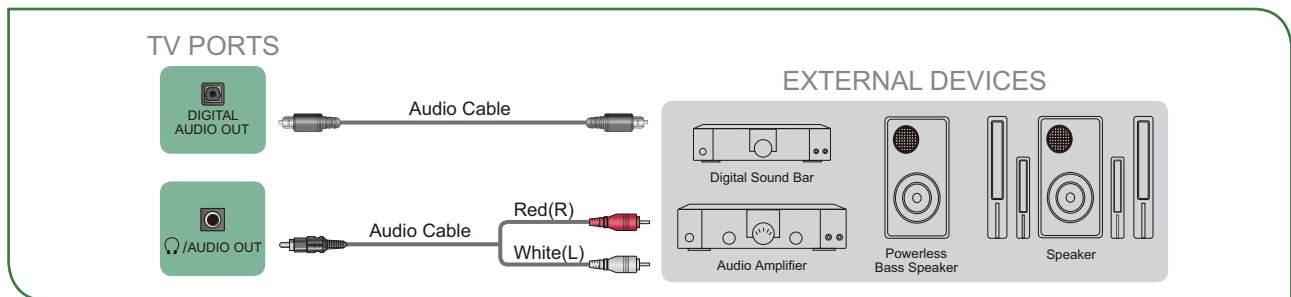

- **TIP:** If you prefer to use Audio Return Channel, then see [Connecting a digital sound bar to use Audio Return Channel \(ARC\) on page 7.](#)

NOTES

- When a digital audio system is connected to the **DIGITAL AUDIO OUT** port, decrease the TV and system volume.
- 5.1 CH (channel) audio is available when the TV is connected to an external device that supports a 5.1 channel surround sound
- You can receive 5.1 channel audio in one of two ways. The first way is to connect the **DIGITAL AUDIO OUT** port from the device to the Amplifier. The second way is to connect the **DIGITAL AUDIO OUT** port on the back of the TV to the Optical port on the Amplifier. After you've completed one of the two methods then be sure to go into the **Advanced Audio Settings** of the TV and select RAW to receive the 5.1 channel audio. You will need to also go into the sound or audio settings of your device to ensure it is set to 5.1 Channel output. It may read 'Bitstream', 'RAW' or 'Digital'.

Connecting a digital sound bar to use Audio Return Channel (ARC)

If you'd like to use the Audio Return Channel (ARC) feature to have sound sent from the TV back down an HDMI cable to a digital sound bar, then you will need to connect the cable to the **HDMI / ARC** port. By using this feature, you will also be able to control the sound bar with your TV remote instead of having to use multiple remotes for each device.

To connect a digital sound bar with an HDMI cable (not provided):

1. Connect the cable that's attached to the sound bar to the **HDMI / ARC** port on the TV.
2. Turn on the sound bar by pressing the Power button.
3. Press the **[MENU]** button on your remote and go to **System > CEC Function**.
4. Turn on the **CEC Control** setting.
5. Turn on the **ARC** setting.
6. Press the **[MENU]** button on you remote and go to **Audio > Advanced Audio Settings > TV Speaker& ARC**. Set it to ARC first.

NOTES

- Only digital sound bars that require a wired connection are compatible with the TV.
- If the device has an Input Selector feature then make sure to change it to TV.

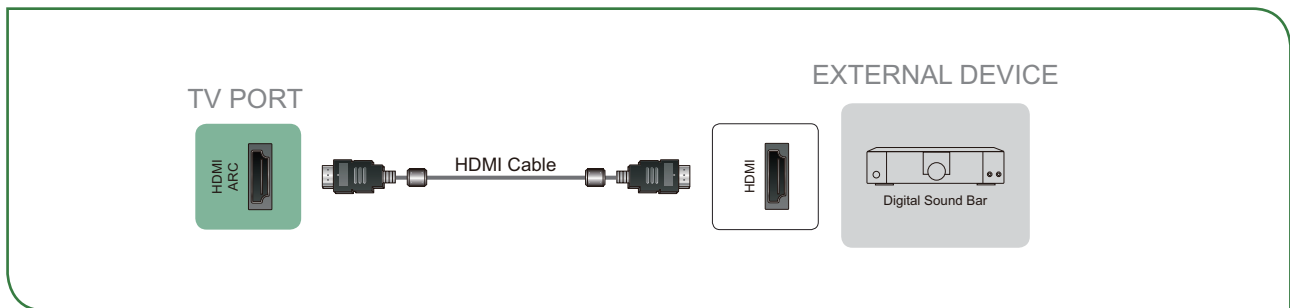

Using Your TV Remote Control

Buttons on your TV remote

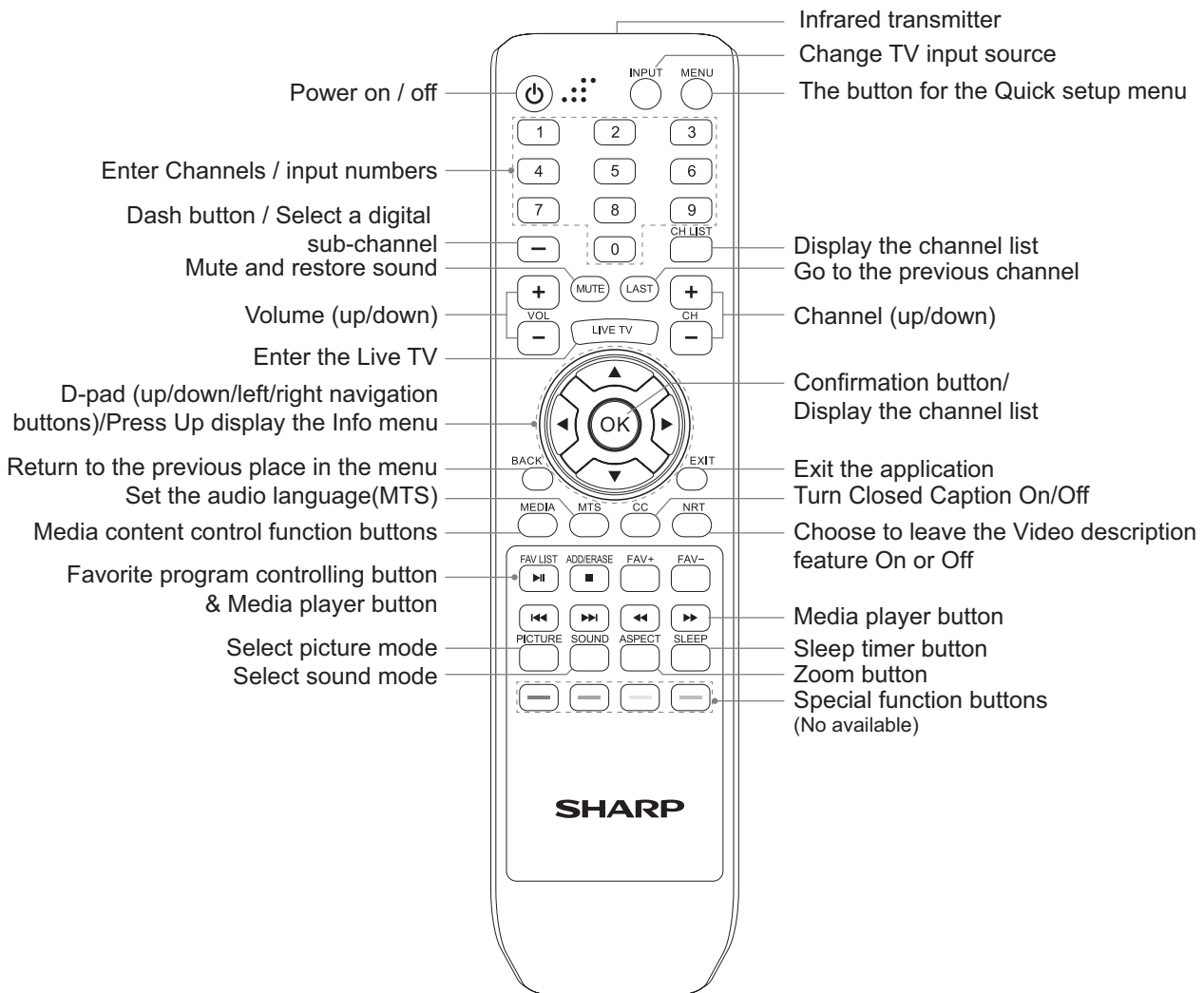

Remote control range information

- The remote control can work at a distance of up to 26 feet in front of the TV set.
- It can work at a 30 degree horizontal or vertical angle.

Begin using your remote

1. Press the battery case cover, when the cover is unlocked, pull it backward to open the battery compartment of the remote control.

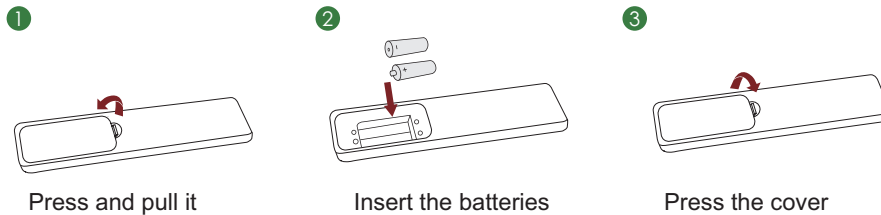

Press and pull it

Insert the batteries

Press the cover

2. Insert two AAA size batteries. Make sure to match the (+) and (-) ends of the batteries with the (+) and (-) ends indicated in the battery compartment.
3. Replace the battery compartment cover.

NOTES

- Discard batteries in a designated disposal area. Do not expose batteries (battery pack or batteries installed) to excessive heat such as sunshine, fire or the like.
- Remove old batteries immediately to prevent them from leaking into the battery compartment.
- If you do not intend to use the remote control for a long time, remove the batteries.
- Battery chemicals can cause a rash. If the batteries leak, clean the battery compartment with a cloth. If chemicals touch your skin then wash it immediately.
- Do not mix old and new batteries.
- Do not mix alkaline, standard (carbon-zinc) or rechargeable (NiCd, NiMH, etc.) batteries.
- Do not continue using the remote if it gets warm or hot.
- Call our Support Center immediately on the SHARP support website.

Program your universal cable or satellite remote control to operate your new SHARP television (only for USA)

If you would like to program your other household remote controls to your new SHARP television, please refer to the User's Manual supplied by your Cable or Satellite provider. The Cable or Satellite providers' User's Manuals should include instructions on how to program their remote to your television.

A list of SHARP codes for the most common Cable and Satellite providers are listed below. Use the SHARP code that is associated with your Cable or Satellite provider (if applicable).

DIRECTV

0178, 10178, 10019, 10748, 11314, 11660, 11710, 11780, 12049, 10171, 11204, 11326, 11517, 11564, 11641, 11963, 12002, 12183

Time Warner Cable

386, 0178, 10178, 400, 450, 461, 456, 0748, 1463, 0463, 10463

Comcast

0178, 10178, 10463, 11463, 10748, 11314, 11660, 10171, 11204, 11326, 11517, 11641, 11780, 11785, 11892, 11963, 12002

Cox Communications

0178, 10178, 1326, 1463

Dish Network

505, 627, 538, 720, 659

If the SHARP code associated with your Cable or Satellite provider is not listed, does not work or you cannot locate the instructions to program your remote, call your local Cable or Satellite provider's customer service center.

If your Cable or Satellite provider does not have a SHARP code available, please contact us.

Using your cable set-top box or satellite receiver remote as a 'Universal' remote

If you prefer to use your Cable Set-top Box or Satellite Receiver Remote as a 'Universal Remote', then visit the Support page to view a list of the codes.

Completing the First-Time Setup Menu

Now that you have attached the TV stand and connected your external devices, it's time to complete the first-time setup menu. The Setup Wizard menu appears the first time you turn on the TV. It will assist you to specify the menu language, Picture Mode, TV Source and Channel Installation.

NOTE

- Before you get started, make sure that the antenna or cable is connected, batteries are in the remote control, and the power cord is connected.

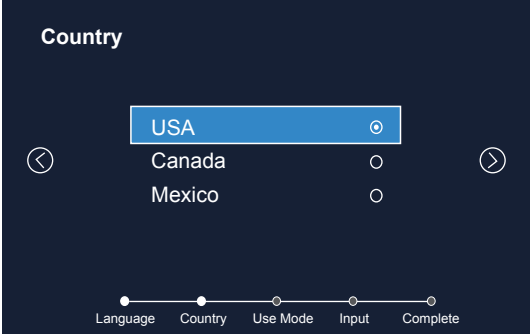
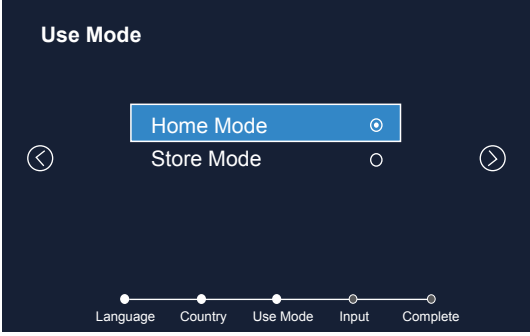
Screen	Task
	<p>Connect your TV's Power cord to a power outlet, then press power. The initial setup screen opens. Press [▲/▼] button to select your language, press [OK] button to confirm.</p>
	<p>Press [▲/▼] button to select your country, press [OK] button to confirm.</p>
	<p>Press [▲/▼] to select your Picture Mode: Home Mode or Store Mode, press [OK] button to confirm.</p>

Screen

Task

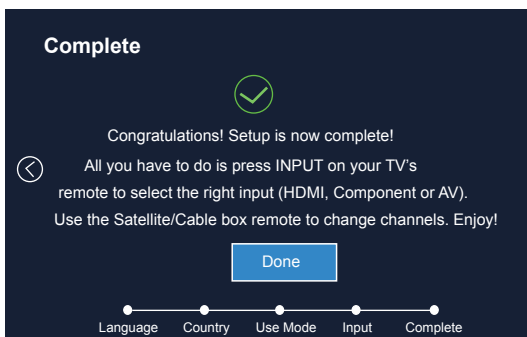
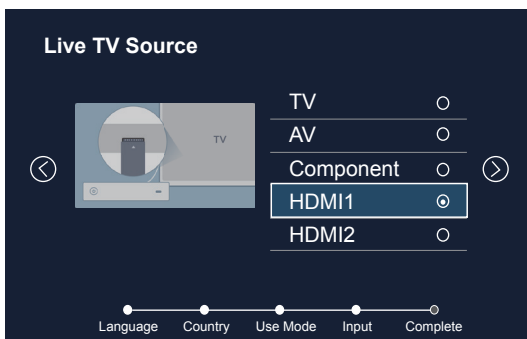
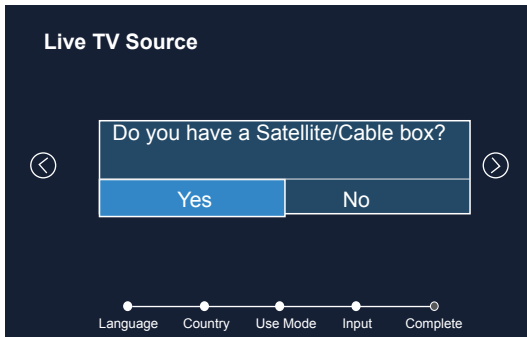

A message appears : Do you have a Satellite/Cable box?

If you select "Yes"

Press [**▲/▼**] to select your TV Source: TV/AV/Component /HDMI1/HDMI2/HDMI3, press [**OK**] button to confirm.

If you select "No", you are done with setup.

Congratulations! Setup is now complete!

All you have to do is press INPUT on your TV's remote to select the right input (HDMI, Component or AV).

Use the Satellite/Cable box remote to change channels. Enjoy!

Shortcuts Instructions

Selecting the input source

The first time you turn on your TV, you must select the TV signal source. Your TV stores this information, so you do not need to change the TV signal source unless it changes. For example, you change from an outside antenna to cable TV.

To select the input source:

1. Turn on your TV, then press the **[INPUT]** button on the remote. The Input source menu opens.
2. Press **[▲/▼]** button to highlight the input source, then press **[OK]** button.

Changing Channels / Volume

1. Press the **[CH + / -]** on the remote control to change the channel.
2. Press the **[VOL + / -]** on the remote control to adjust the volume.
3. Press the numeric buttons on the remote control to display the corresponding channels.

NOTE

- Changing the channels can also be achieved by directly entering the channel number using the numeric keys on the remote control. If you are entering a two or three digit channel number, the time between key presses should be less than 3 seconds.

Channel search guide

When you select TV as input, if no TV channels were saved before, you will be prompted to do a channel search.

Shortcuts Instructions

PICTURE

Press to set the picture mode. It can be set as Energy Saving, Movie, Game, Sport, User, Vivid and Standard, This mode achieves a certain image display effect by setting the brightness, contrast and color etc.

SOUND

Press to set the sound mode. It can be set as Standard, Theater, Music, Speech, Late Night and User.

MUTE

Press to turn the sound off, press this button again to turn the sound back on. This function is used to switch off sound temporarily.

SLEEP

It can set the TV to let it enter into the Standby state automatically. Press this button repeatedly to select the proper sleeping clock mode, and the clock tells you the remaining time before the TV enters Standby state.

ASPECT

Select the screen aspect ratio from Wide, Auto, Normal, Zoom Cinema, 1:1 PIXEL MAP, Panoramic and Direct.

NOTE

- The aspect ratio varies with different sources.

Basic Settings

Your SHARP TV comes with many TV setting features to allow you to customize the picture based on your viewing preference and environment.

Using the Menu

1. Press **[MENU]** to open the main menu.
2. Press **[▲/▼]** to select a menu option, then press **[OK]** button to enter the menu.
3. In each menu, you can:
 - Press **[▲/▼]** to select an item,
 - Press **[◀/▶]** to adjust the value,
 - Press **[OK]** to enter the submenu,
4. Press **[EXIT]** to exit the menu.

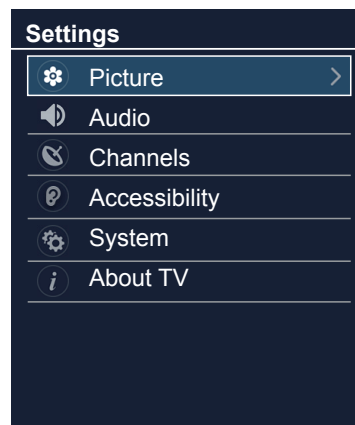

NOTE

- The menus in the user manual may vary slightly from the actual screen.



Picture Menu

You can adjust:

- **Picture Mode:** Adjust the Picture Mode. You can select Energy Saving, Movie, Game, Sport, User, Vivid and Standard.
 - **Brightness:** Increase or decrease the brightness of the picture. Increasing the brightness can add more light to dark areas of the picture, while decreasing the brightness can add more darkness to light areas of the picture.
 - **Contrast:** Increase or decrease the contrast of the picture. Increase the contrast to adjust the white areas of the picture or decrease the contrast to adjust the black areas of the picture.
 - **Color:** Adjusts the color intensity of the picture. A low setting may make the color look faded. A high setting may make the color look artificial.
 - **Tint:** Adjusts the color balance of the picture. Use this control to make skin tones look more natural.
 - **Sharpness:** You can increase the sharpness level for clearer images or decrease the sharpness level for smoother images.
 - **Backlight:** Sets the overall brilliance of the screen. You can select Dynamic Backlight or Backlight.
 - **Advanced Picture Settings:**
 - **Adaptive Contrast:** Automatically adjusts picture detail and brightness. You can select On or Off.
 - **Color Temperature:** Change the color temperature. You can select the color temperature from three options: Cool, Normal or Warm.
 - **Noise Reduction:** Select to reduce the noise level of connected equipment: off, Low, Medium and High.
 - **Overscan:** Adjusts the picture's reproduction rate. You can select On or Off.
-  **NOTE**
- Only available in DTV, Component and HDMI(YUV) source.
 - **Color Tuner:** Adjust the Hue, Saturation and Brightness of color settings.
 - **White Balance:** Adjust the intensity of red, green and blue lights to view the true colors of all images in the picture.
 - **Aspect Ratio:** To choose the screen aspect ratio from Wide, Auto, Normal, Zoom Cinema, 1:1 PIXEL MAP, Panoramic and Direct.
-  **NOTE**
- The Aspect Ratio option is different in different inputs. For more information.
 - **Restore Default Picture Settings:** Restore all the picture settings in the current picture mode to the factory default values.

< Picture	
Picture Mode	< Standard >
Brightness	50
Contrast	50
Color	50
Tint	0
Sharpness	10
Backlight	
Advanced Picture Settings	
Aspect Ratio	Wide
Restore Default Picture Settings	

Audio Menu

You can adjust:

- **Sound Mode:** Select the Sound Mode: Standard, Theater, Music, Speech, Late Night or User.
 - **Sound Surround :** Select the Sound Surround On or Off.
 - **Dialog Clarity:** Select the Dialog Clarity High, Low or Medium.
 - **Equalizer:** Soften or enhance the sound at specific frequency points.
- **SAP:** Select the default audio stream, you can select Mono, Stereo or SAP (Second Audio Program).

Mono: Select this option if there is noise or static on weak stereo broadcasts.

Stereo: Select this option for programs broadcast in stereo.

SAP: Depending on the particular program being broadcast, you can listen to a foreign-language translation.

NOTE

- Only available in Analog channels.

- **Preferred Audio Language:** Change the default value for audio language.

NOTE

- Only available in Digital channels.

- **Advanced Audio Settings:** Access Advanced Audio settings such as AVC, Digital Audio Out, Digital Audio Delay, Lip Sync, TV Speaker & ARC, Balance, or Audio Out.

- **AVC:** Select the AVC On or Off.

- **Digital Audio Out:** Send digital audio to an external audio system. You can select PCM, RAW or Off.

PCM: PCM outputs two channel audio regardless of the input format.

RAW: When the data stream carries Dolby signal, digital SPDIF outputs Dolby data stream. When the data stream carries no Dolby signal, it transports PCM data stream.

- **Digital Audio Delay:** Adjust the digital audio output delay time to sync sound from an external speaker with the images on the TV.

- **Lip Sync:** Synchronize the displayed image with the audio output.

- **TV Speaker & ARC:** Selects where to play TV audio. You can select ARC First, Speaker or Off.

- **Balance:** Adjust the volume of the left and right speakers.

- **Audio Out:** Change the way audio is sent through the type of device that's connected to your TV Audio Out port.

- **Restore Default Audio Settings:** Restore all of the Audio settings in current audio mode to the factory default values.

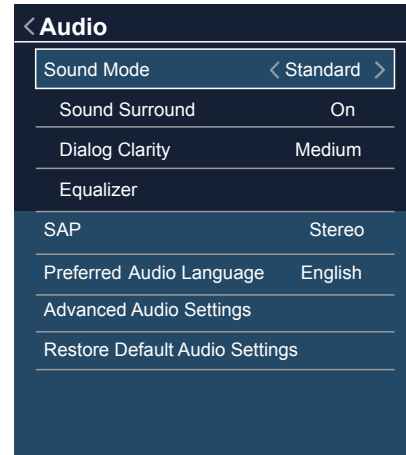

Channels Menu

You can adjust:

- **Tuner Mode:** Select the TV signal source. You can select Antenna or Cable.
- **Auto Channel Scan:** Automatically scan for channels to view programming from your TV source.
- **Manual Scan:** TV should support Manual Scan. User can input the channel number that he want to search. Then TV can search include STD, HRC and IRC.
- **Channel Skip:** Skip a channel that your TV picked up during a previous channel scan search.
- **Favorite List:** Display your Favorite List. You can add or delete channels to create your favorite list.

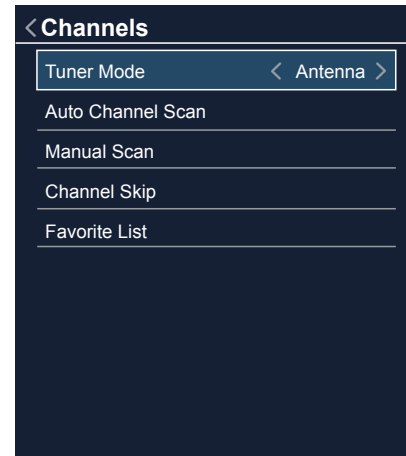

Accessibility Menu

You can adjust:

- **Video Description:** Choose to leave the Video description feature On or Off.
- **Menu Audio :** Choose to leave the Audio Menu Prompts On or Off.
- **Menu Audio Settings :** Adjust Menu Audio settings to your preference.
 - **Volume:** Set the Menu Audio volume.
 - **Rate:** Set the Menu Audio speed.
 - **Pitch:** Set the Menu Audio pitch.
- **High Contrast Menu :** Choose to leave the high contrast menu On or Off.
- **Closed Caption :** Select the Closed Caption CC Off, CC On or CC On Mute.
- **Closed Caption Settings :** Adjust Closed Captioning settings.
 - **Analog Caption:** Select an Analog Caption setting from CC1-CC4, Text 1-Text4.
 - **CC1-CC4:** Closed captioning appears in a small banner across the bottom of the screen. CC1 is usually the “printed” version of the audio. CC2-CC4 display content are provided by the broadcaster.
 - **Text1-Text4:** Closed captioning that covers half or all of the screen. Text1-Text4 display content are provided by the broadcaster.
 - **Digital Caption:** Select a Digital Caption setting: Off, Service1-Service6.
 - **Digital CC Setting:** There are two caption styles. One is the Automatic function set as the broadcaster, while the other is the Custom style where you can adjust the Size, Font, Text Color, Text Opacity, Background Color etc.

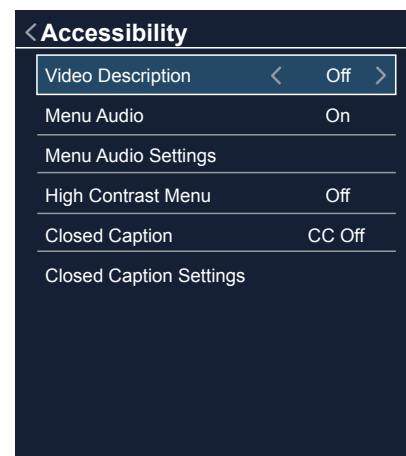

System Menu

You can adjust:

- **Menu Language:** You can select the menu language to English, Spanish or French.
- **Location:** Choose the location from where you will watch your TV.
- **Time:** Set the current time based on your location.
 - **Time Zone:** Select your local time zone: Eastern, Central, Indiana, Arizona, Mountain, Pacific, Alaska, Hawaii, Newfoundland and Atlantic.
 - **Daylight Savings:** Press [▲ / ▼] to highlight Daylight Savings, then press [◀ / ▶] to select Auto (if your viewing area observes Daylight Savings Time) or Off (if your viewing area does not observe Daylight Savings Time).
 - **Auto synchronization:** Select Manual (to set the date and time manually) or Auto (to set the date and time automatically from a TV signal source based on the time zone you select).

If you selected Manual, set the following options.

Date / Time: You can set time manually or select automatic if the TV is connected to an antenna or cable source.

Date: Set the current month / day / year.

Time: Set the current time.

- **Time Format:** Set the time to display in a 12 or 24-hour format.
- **Sleep Timer:** Specify the amount of time before your TV automatically turns off.
- **Menu Timeout:** Set the amount of time that you'd like for the menu to display : 10s, 20s , 30s , 60s or Off.
- **Parental Controls:** When you first use this function, the default password is [0000]. Once you input this password, you can set options.
 - **Locks:** Block or unblock the button of the TV.
 - US TV Ratings:** Restrict TV programs by USA Ratings.
 - US Movie Ratings:** Restrict movies by USA Ratings.
 - Canadian English/French Ratings:** Restrict movies and TV programs by Canadian Ratings.
 - Open V-Chip:** Display an advanced V-Chip ratings table for digital channels (USA only).
 - Block Unrated :** Block unrated TV programs.
 - **Input Block:** Block content from devices that are connected to certain TV ports.
 - **Change PIN:** Change your PIN that you use to access Parental Controls. If you want to change your parental control password, first enter the new password then enter the same password again.

NOTE

If you forget your password, call the **Consumer Electronics Care Center**.

- **Restore Parental Control Defaults:** Restore Parental Controls back to the factory setting.

Following is the description of these ratings.

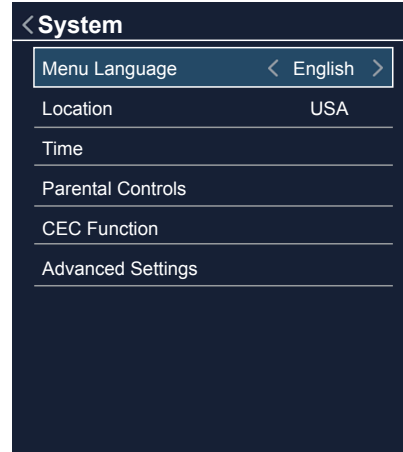

US TV Ratings

Age	Defined as
TV-Y	All children
TV-Y7	Directed to older children
TV-G	General audience
TV-PG	Parental Guidance suggested
TV-14	Parents strongly cautioned
TV-MA	Mature Audience only

Content	Defined as
ALL	All of the ratings below that rating set blocked automatically
D	Suggestive dialogue
L	Strong language
S	Sexual situations
V	Violence
FV	Fantasy Violence

US Movie Ratings

Rating	Defined as
N/A	OFF
G	General audience
PG	Parental Guidance suggested
PG-13	Parents strongly cautioned
R	Restricted
NC-17	No one 17 and under admitted
X	Adult audience only

Canadian English Ratings

Rating	Defined as
E	OFF
C	Children
C8+	Children 8 years and older
G	General programming, suitable for all audiences
PG	Parental Guidance
14+	Viewers 14 years and older
18+	Adult Programming

Canadian French Ratings

Rating	Defined as
E	OFF
G	General
8 ans+	8+General; Not recommended for young children
13 ans+	Programming may not be suitable for children under the age of 13
16 ans+	Programming is not be suitable for children under the age of 16
18 ans+	Programming restricted to adults

NOTE

- As you block ratings, all ratings higher than those that you selected are blocked too. For example, if you choose to block the MPAA rating R, then the higher ratings (NC-17 and X) are also automatically blocked.
- **CEC Function:** CEC Function lets you control HDMI CEC-compatible devices connected to the HDMI ports on your TV using the remote control that came with your TV. To use CEC Function, you must set the CEC Control setting to On.
 - **CEC Control:** Turning CEC function on or off.
 - **Device Auto Power Off:** When HDMI-CEC is turned on, Device Auto Power Off turns off HDMI CEC devices when you turn off your TV.
 - **TV Auto Power On:** When CEC is turned on and you turn on an HDMI CEC device, TV Auto Power On turns on your TV automatically.
 - **Detect:** Search all the device connected to our TV.
 - **Device List:** You can display a list of HDMI CEC devices that are connected to your TV and select the source you want.
 - **ARC:** You can select the ARC on or off.
- **Advanced Settings:** Access the Advanced Settings menu.
 - **Audio Only:** You can select the Audio only On/Off.
 - **Input Label:** Edit the input labels.
 - **Live TV Source:** Select the default input selected by the remote control Live TV button.
 - **Setup Wizard:** Use the Setup Wizard for instructions to help you set up your TV.
 - **Use Mode:** You can select the Home Mode / Store Mode.

About TV Menu

- **Version:** View system information.
- **USB Firmware Upgrade:** You can update the software from the USB device.
- **Restore To Factory Default:** Restore your TV back to the factory default.

Media

Digital Media player

Please note that SHARP will not assume any responsibility for any lost data and cannot guarantee perfect compatibility with all mass storage devices. Be sure to insert the USB flash drive into the USB 2.0 port. Data Input from USB Memory Stick only. Do not connect any device to this terminal such as digital camera, keyboard, mouse, etc.

NOTE

- Never remove the USB flash drive or turn off your TV while viewing movie / photo.
- Press **[INPUT]** button to display the INPUT menu, press **[▲/▼]** button to highlight the Media source, then press **[OK]** button to confirm. (If you want to exit Media, you can press **[INPUT]** button to switch to other sources).
- The Media screen displays three panels: **Photo**, **Music** and **Movie**.

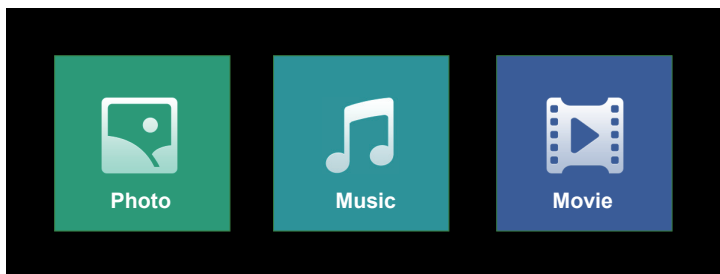

File formats that may be supported

NOTE

- Due to differences in programming tools and other factors, some of the file formats that are listed may or may not be supported.

Medium	File Format
Movie	.avi (MPEG2, Divx), .mkv (Divx), .mpeg (MPEG2), .wmv (Divx, XviD), .ts .trp .tp(mpeg) .mp4
Photo	.JPG
Music	.mp3

Media content control function buttons

When viewing movie / photo, you can press these buttons on the remote control to control movie / photo.

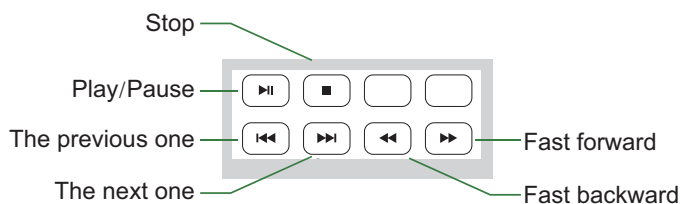

Browse the Photos

1. Press [◀/▶] button to switch the media type to Photo.
2. Press [▲/▼/◀/▶] to select the photo you want to view.
3. Press [OK] to browse the photo.
4. Press [BACK] to return to the previous directory.
5. Press [OK] to enter the submenu and press [EXIT] to return to the upper menu.

Tool bar

NOTE

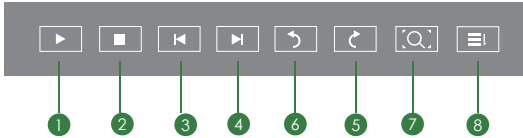

- The menu will change while you are browsing through or pausing your photos.

- 1 Play / Pause the photo.
- 2 Stop browsing the photo.
- 3 Browse the previous photo.
- 4 Browse the next photo.
- 5 Allows the photo to rotate 90 degrees anti-clockwise.
- 6 Allows the photo to rotate 90 degrees clockwise.
- 7 Zoom the photo.
- 8 Play mode selection.

Enjoy Music Files

1. Press [◀/▶] button to switch the media type to Music.
2. Press [▲/▼/◀/▶] to select the music you want to view.
3. Press [OK] to browse the music.
4. Press [BACK] to return to the previous directory.
5. Press [OK] to enter the submenu and press [EXIT] to return to the upper menu.

Tool bar

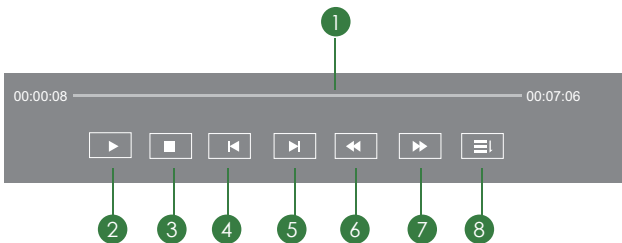

- 1 Progress bar.
- 2 Play / Pause the video.
- 3 Stop playback.
- 4 Play the previous video.
- 5 Play the next video.
- 6 Fast backward. Press [OK] to select the backward speed.
- 7 Fast forward. Press [OK] to select the forward speed.
- 8 Play mode selection.

Enjoy Movie Files

1. Press [◀/▶] button to switch the media type to Movie.
2. Press [▲/▼/◀/▶] to select the movie you want to view.
3. Press [OK] to play the movie.
4. Press [BACK] to exit the video and return to the previous directory.
5. When enjoying the video, press [OK] button to display the tool bar. Press [EXIT] to return to the upper menu.

Tool bar

- 1 Progress bar.

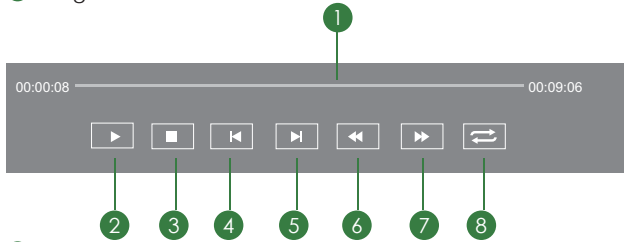

- 2 Play / Pause the video.
- 3 Stop playback.
- 4 Play the previous video.
- 5 Play the next video.
- 6 Fast backward. Press [OK] to select the backward speed.
- 7 Fast forward. Press [OK] to select the forward speed.
- 8 Loop the video.

NOTES

- This TV will only recognize a USB Memory Stick.
- Do not use a USB hub or an extension cable to connect an external hard disk drive to the unit. (Not supported)
- Always insert a USB Memory Stick directly into the USB port.
- A USB Memory Stick is not supplied with this unit.
- We do not guarantee that all USB Memory Sticks can be supported by this unit.
- Be sure to keep a backup copy of the original files on your device before you play them back on this unit. We have no responsibilities for damage or loss of your stored data.
- To protect your USB Memory Stick files from being erased place the write protect sliding tab in the protect position.
- When you are ready to remove a USB Memory Stick, set the unit to go into Standby mode to avoid any damage to your data and the unit.
- A USB Memory Stick that requires its own driver or the device with a special system such as fingerprint recognition are not supported.
- This unit is not allowed to use the USB Memory Stick which requires an external power supply (500mA or more).

Quick Problem-Solving Tips

When you experience an issue with your TV, turn it off and on again. If this does not resolve the problem, then refer to the tips below. If the problem is still not resolved, then contact us.

ISSUES	POSSIBLE SOLUTIONS
No sound or picture	<ul style="list-style-type: none"> • Check if the power cord is plugged into a powered AC outlet. • Press the [⏻] button on the remote control to activate the unit from 'Standby' mode. • Check to see if the LED light is on or not. If it is, then the TV is receiving power.
I have connected an external source to my TV and I get no picture and/or sound	<ul style="list-style-type: none"> • Check for the correct output connection on the external source and for the correct input connection on the TV. • Make sure you have made the correct selection for the input mode for the incoming signal.
When I turn on my TV, there is a delay for a few seconds before the picture appears. Is this normal?	<ul style="list-style-type: none"> • Yes, this is normal. The TV is initializing and searching for previous setting information.
The picture is normal but there is no sound	<ul style="list-style-type: none"> • Check the volume settings. • Check if 'Mute' mode is set to On.
Sound but no picture or black and white picture	<ul style="list-style-type: none"> • If the picture is black and white, unplug the TV from the AC outlet and replug it after 60 seconds. • Check that the Color is set to 50 or higher. • Try different TV channels.
The sound and/or picture is distorted or appears wavy	<ul style="list-style-type: none"> • An electric appliance may be affecting the TV. Turn off any appliances that are nearby and move it farther away from the TV. • Insert the power plug of the TV set into another power outlet.
The sound and picture is blurry or cuts out	<ul style="list-style-type: none"> • If using an external antenna, check the direction, position and connection of the antenna. • Adjust the direction of your antenna or reset or fine tune the channel.
A horizontal or vertical stripe appears on the picture and/or the picture is shaking	<ul style="list-style-type: none"> • Check if there is an appliance or electric tool nearby that is causing interference.
The plastic cabinet makes a "clicking" type of sound	<ul style="list-style-type: none"> • The 'click' sound can occur when the temperature of the television changes. This change causes the television cabinet to expand or contract, which makes the sound. This is normal and the TV is OK.
The remote control does not work	<ul style="list-style-type: none"> • Confirm that TV still has power and is operational. • Change the batteries in the remote control. • Check if the batteries are correctly installed.

NOTE

- For usage in Mexico, operation of this equipment is subject to the following two conditions: 1) it is possible that this device doesn't cause any detrimental interference and 2) this device must take any kind of interference, including that which may cause its malfunctioning.

ENGLISH

FRANÇAIS
▲

ESPAÑOL
▲