

XCP – The Standard Protocol for ECU Development

Fundamentals and Application Areas

Andreas Patzer | Rainer Zaiser

Andreas Patzer | Rainer Zaiser

XCP – The Standard Protocol for ECU Development



Date December 2016

Reproduction only with expressed permission from

Vector Informatik GmbH, Ingersheimer Str. 24, 70499 Stuttgart, Germany

© 2016 by Vector Informatik GmbH. All rights reserved. This book is only intended for personal use, but not for technical or commercial use. It may not be used as a basis for contracts of any kind. All information in this book was compiled with the greatest possible care, but Vector Informatik does not assume any guarantee or warranty whatsoever for the correctness of the information it contains. The liability of Vector Informatik is excluded, except for malicious intent or gross negligence, to the extent that laws do not make it legally liable.

Information contained in this book may be protected by copyright and/or patent rights. Product names of software, hardware and other product names that are used in this book may be registered brands or otherwise protected by branding laws, regardless of whether or not they are identified as registered brands.

XCP

The Standard Protocol for ECU Development

Fundamentals and Application Areas

Andreas Patzer, Rainer Zaiser
Vector Informatik GmbH

Table of Contents

Introduction.....	7
1 Fundamentals of the XCP Protocol.....	13
1.1 XCP Protocol Layer.....	19
1.1.1 Identification Field.....	21
1.1.2 Timestamp.....	21
1.1.3 Data Field.....	22
1.2 Exchange of CTOs.....	22
1.2.1 XCP Command Structure.....	22
1.2.2 CMD.....	25
1.2.3 RES.....	28
1.2.4 ERR.....	28
1.2.5 EV.....	29
1.2.6 SERV.....	29
1.2.7 Calibrating Parameters in the Slave.....	29
1.3 Exchanging DTOs – Synchronous Data Exchange.....	32
1.3.1 Measurement Methods: Polling versus DAQ.....	33
1.3.2 DAQ Measurement Method.....	34
1.3.3 STIM Calibration Method.....	42
1.3.4 XCP Packet Addressing for DAQ and STIM.....	43
1.3.5 Bypassing = DAQ + STIM.....	45
1.3.6 Time Correlation and Synchronization.....	45
1.4 XCP Transport Layers.....	49
1.4.1 CAN.....	49
1.4.2 CAN FD.....	52
1.4.3 FlexRay.....	54
1.4.4 Ethernet.....	57
1.4.5 Sxl.....	59
1.4.6 USB.....	60
1.4.7 LIN.....	60
1.5 XCP Services.....	61
1.5.1 Memory Page Swapping.....	61
1.5.2 Saving Memory Pages – Data Page Freezing.....	63
1.5.3 Flash Programming.....	63
1.5.4 Automatic Detection of the Slave.....	65
1.5.5 Block Transfer Mode for Upload, Download and Flashing.....	66
1.5.6 Cold Start Measurement.....	67
1.5.7 Security Mechanisms with XCP.....	68

2 ECU Description File A2L.....71

2.1 Setting Up an A2L File for an XCP Slave 74
2.2 Manually Creating an A2L File..... 75
2.3 A2L Contents versus ECU Implementation..... 76

3 Calibration Concepts 79

3.1 Parameters in Flash 80
3.2 Parameters in RAM 82
3.3 Flash Overlay 84
3.4 Dynamic Flash Overlay Allocation 85
3.5 RAM Pointer Based Calibration Concept per AUTOSAR 86
 3.5.1 Single Pointer Concept 86
 3.5.2 Double Pointer Concept 88
3.6 Flash Pointer Based Calibration Concept 89

4 Application Areas of XCP 91

4.1 Model in the Loop (MIL) 93
4.2 Software in the Loop (SIL) 94
4.3 Hardware in the Loop (HIL) 95
4.4 Rapid Control Prototyping (RCP) 97
4.5 Bypassing 98
4.6 Shortening Iteration Cycles with Virtual ECUs 101

5 Example of an XCP Implementation 105

5.1 Description of Functions 108
5.2 Parameterization of the Driver 110

6 Protocol Development Overview 111

6.1 XCP Version 1.1 (2008) 112
6.2 XCP Version 1.2 (2013) 112
6.3 XCP Version 1.3 (2015) 113

The Authors 114
Table of Abbreviations and Acronyms 116
Literature 117
Web Addresses 117
Table of Figures 118
Appendix – XCP Solutions at Vector 120
Index 122

Introduction

In optimal parameterization (calibration) of electronic ECUs, you calibrate parameter values during the system runtime and simultaneously acquire measured signals. The physical connection between the development tool and the ECU is via a measurement and calibration protocol. XCP has become established as a standard here.

First, the fundamentals and mechanisms of XCP will be explained briefly and then the application areas and added value for ECU calibration will be discussed.

First, some facts about XCP:

- > XCP signifies "Universal Measurement and Calibration Protocol". The "X" stands for the variable and interchangeable transport layer.
- > It was standardized by an ASAM working committee (Association for Standardisation of Automation and Measuring Systems). ASAM is an organization of automotive OEMs, suppliers and tool producers.
- > XCP is the protocol that succeeds CCP (CAN Calibration Protocol).
- > The conceptual idea of the CAN Calibration Protocol was to permit read and write access to internal ECU data over CAN. XCP was developed to implement this capability via different transmission media. Then one speaks of XCP on CAN, XCP on FlexRay or XCP on Ethernet.
- > The primary applications of XCP are measurement and calibration of internal ECU parameters. Here, the protocol offers the ability to acquire measured values "event synchronous" to processes in ECUs. This ensures consistency of the data between one another.

To visualize the underlying idea, we initially view the ECU and the software running in it as a black box. In a black box, only the inputs into the ECU (e.g. CAN messages and sensor values) and the output from the ECU (e.g. CAN messages and actuator drives) are acquired. Details about the internal processing of algorithms are not immediately apparent and can only be determined from an analysis of the input and output data.

Now imagine that you had a look into the behavior of your ECU with every computation cycle. At any time, you could acquire detailed information on how the algorithm is running. You would no longer have a black box, but a white box instead with a full view of internal processes. That is precisely what you get with XCP!

What contribution can XCP make for the overall development process? To check the functionality of the attained development status, the developer can execute the code repeatedly. In this way, the developer finds out how the algorithm behaves and what might be optimized. It does not matter here whether a compiled code runs on a specific hardware or whether it is developed in a model-based way and the application runs in the form of a model.

A central focus is on the evaluation of the algorithm process. For example, if the algorithm is running as a model in a development environment, such as Simulink from The MathWorks, it is helpful to developers if they can also acquire intermediate results to their applications, in order to obtain findings about other changes. In the final analysis, this method enables nothing other than read access to parameters so that they can be visualized and analyzed –

and all of this at model runtime or retrospectively after a time-limited test run has been completed. A write access is needed if parameterizations are changed, e.g. if the proportional component of a PID controller is modified to adapt the algorithm behavior to the system under control. Regardless of where your application runs – focal points are always the detailed analysis of algorithm processes and optimization by changes to the parameterization.

This generalization can be made: The algorithms may exist in any type of executable form (code or model description). Different systems may be used as the runtime environment (Simulink, as DLL on the PC, on a rapid prototyping platform, in the ECU etc.). Process flows are analyzed by read access to data and acquisition of its time-based flow. Parameter sets are modified iteratively to optimize algorithms. To simplify the representation, the acquisition of data can be externalized to an external PC-based tool, although it is understood here that runtime environments themselves can even offer analysis capabilities.

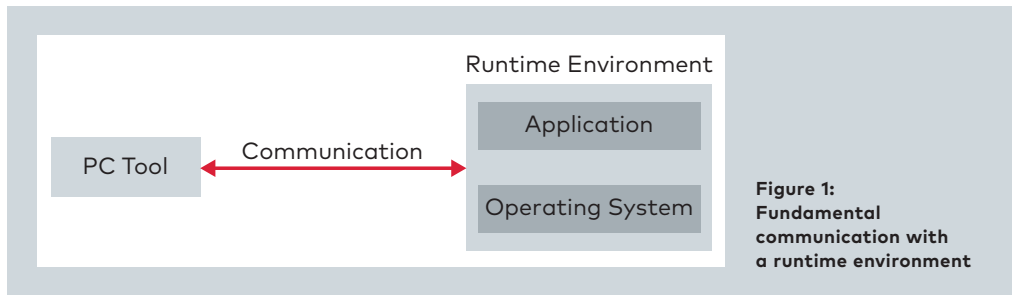

The type of runtime environment and the form of communication generally differ from one another considerably. The reason is that the runtime environments are developed by different producers and are based on different solution approaches. Different types of protocols, configurations, measurement data formats, etc. make it a futile effort to try to exchange parameter sets and results in all development steps. In the end, however, all of these solutions can be reduced to read and write access at runtime. And there is a standard for this: XCP.

XCP is an ASAM standard whose Version 1.0 was released in 2003. The acronym ASAM stands for "Association for Standardisation of Automation and Measuring Systems." Suppliers, vehicle OEMs and tool manufacturers are all represented in the ASAM working group. The purpose of the XCP working group is to define a generalized measurement and calibration protocol that can be used independent of the specific transport medium. Experience gained from working with CCP (CAN Calibration Protocol) flowed into the development as well.

XCP was defined based on the ASAM interfaces model. The following figure shows a measurement and calibration tool's interfaces to the XCP Slave, to the description file and the connection to a higher-level automation system.

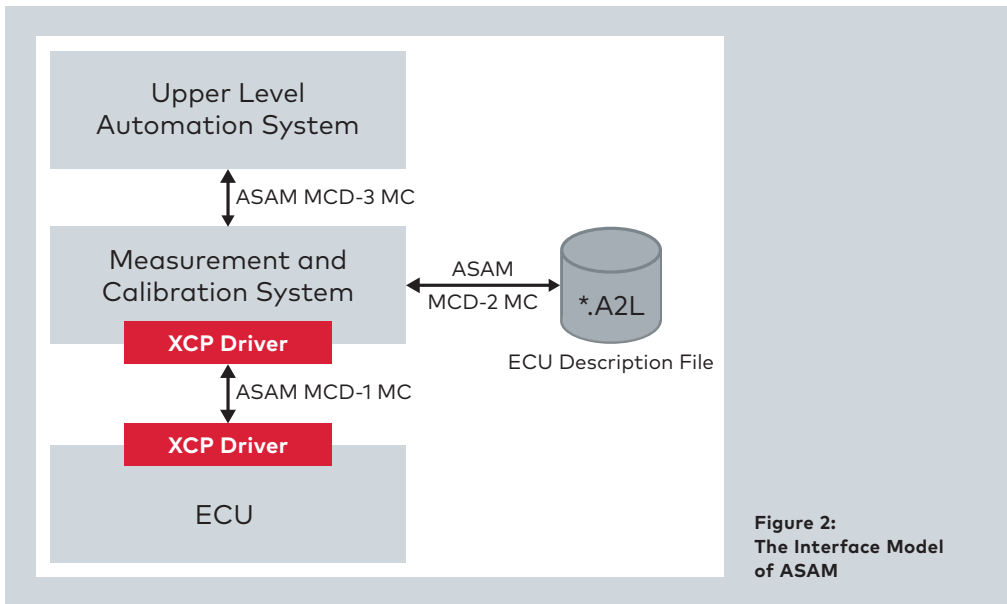

Interface 1: "ASAM MCD-1 MC" between ECU and measurement & calibration system

This interface describes the physical and the protocol-specific parts. Strictly speaking, a distinction was made between interfaces ASAP1a and ASAP1b here. The ASAP1b interface, however, never received general acceptance and for all practical purposes it has no relevance today. The XCP protocol is so flexible that it can practically assume the role of a general manufacturer-independent interface. For example, today all measurement and calibration hardware manufacturers offer systems (xETK, VX1000, etc.) which can be connected via the XCP on Ethernet standard. An ASAP1b interface – as it was still described for CCP – is no longer necessary.

Interface 2: "ASAM MCD-2 MC" A2L ECU description file

As already mentioned, XCP works in an address-oriented way. Read or write accesses to objects are always based on an address entry. Ultimately, however, this would mean that the user would have to search for his ECU objects in the Master based on the address. That would be extremely inconvenient. To let users work with symbolic object names, for example, a file is needed that describes the relationship between the object name and the object address. The next chapter is devoted to this A2L description file.

Interface 3: "ASAM MCD-3 MC" automation interface

This interface is used to connect another system to the measurement and calibration tool, e.g. for test bench automation. The interface is not further explained in this document, because it is irrelevant to understanding XCP.

XCP is based on the Master-Slave principle. The ECU is the Slave and the measurement and calibration tool is the Master. A Slave may only communicate with one Master at any given time; on the other hand, the Master can simultaneously communicate with many Slaves.

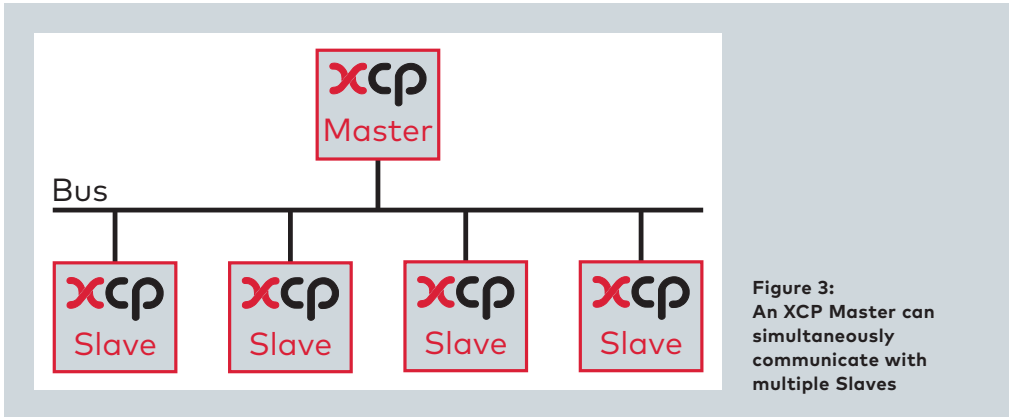

Figure 3:
An XCP Master can simultaneously communicate with multiple Slaves

To be able to access data and configurations over the entire development process, XCP must be used in every runtime environment. Fewer tools would need to be purchased, operated and maintained. This would also eliminate the need for manual copying of configurations from one tool to another, a process that is susceptible to errors. This would simplify iterative loops, in which results from later work steps are transferred back to prior work steps.

But let us turn our attention away from what might be feasible to what is possible today: everything! XCP solutions are already used in a wide variety of work environments. It is the intention of this book to describe the main properties of the measurement and calibration protocol and introduce its use in the various runtime environments. What you will not find in this book: neither the entire XCP specification in detailed form, nor precise instructions for integrating XCP drivers in a specific runtime environment. It explains the relationships, but not the individual protocol and implementation details. Internet links in the appendix refer to openly available XCP driver source code and sample implementations, which let you understand and see how the implementation is made.

Screenshots of the PC tool used in this book were prepared using the CANape measurement and calibration tool from Vector. Other process flows are also explained based on CANape, including how to create an A2L file and even more. With a cost-free demo version, which is available to you in the Download Center of the Vector website at www.vector.com/canape_demo, you can see for yourself

1 Fundamentals of the XCP Protocol

Interface 1 of the ASAM interfaces model describes sending and receiving commands and data between the Slave and the Master. To achieve independence from a specific physical transport layer, XCP was subdivided into a protocol layer and a transport layer.

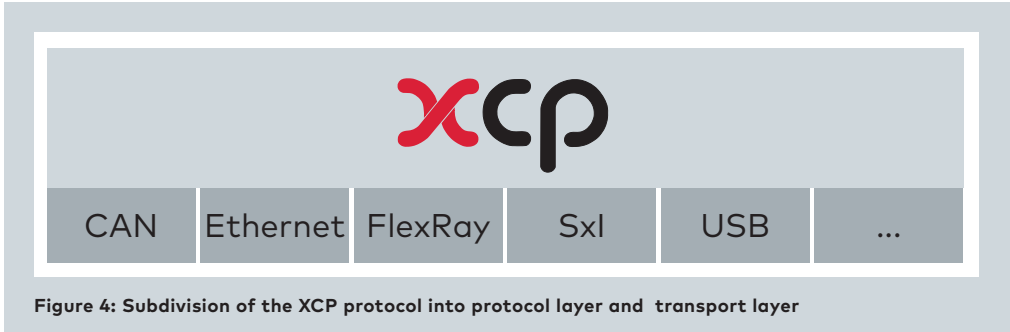

Figure 4: Subdivision of the XCP protocol into protocol layer and transport layer

Depending on the transport layer, one refers to XCP on CAN, XCP on Ethernet, etc. The extensibility to new transport layers was proven as early as 2005 when XCP on FlexRay made its debut. The current version of the XCP protocol is Version 1.3, which was approved in 2015.

Adherence to the following principles was given high priority in designing the protocol:

- > Minimal resource usage in the ECU
- > Efficient communication
- > Simple Slave implementation
- > Plug-and-play configuration with just a small number of parameters
- > Scalability

A key functionality of XCP is that it enables read and write access to the memory of the Slave.

Read access lets users measure the time response of an internal ECU parameter. ECUs are systems with discrete time behavior, whose parameters only change at specific time intervals: only when the processor recalculates the value and updates it in RAM. One of the great strengths of XCP lies in acquiring measured values from RAM which change synchronously to process flows or events in the ECU. This lets users evaluate direct relationships between time-based process flows in the ECU and the changing values. These are referred to as event-synchronous measurements. The related mechanisms will be explained later in detail.

Write access lets the user optimize parameters of algorithms in the Slave. The accesses are address-oriented, i.e. the communication between Master and Slave references addresses in memory. So, the measurement of a parameter is essentially implemented as a request of the Master to the Slave: "Give me the value of memory location 0x1234". Calibration of a parameter – the write access – to the Slave means: "Set the value at address 0x9876 to 5".

An XCP Slave does not absolutely need to be used in ECUs. It may be implemented in different environments: from a model-based development environment to hardware-in-the-loop and software-in-the-loop environments to hardware interfaces that are used to access ECU memory via debug interfaces such as JTAG, NEXUS and DAP.

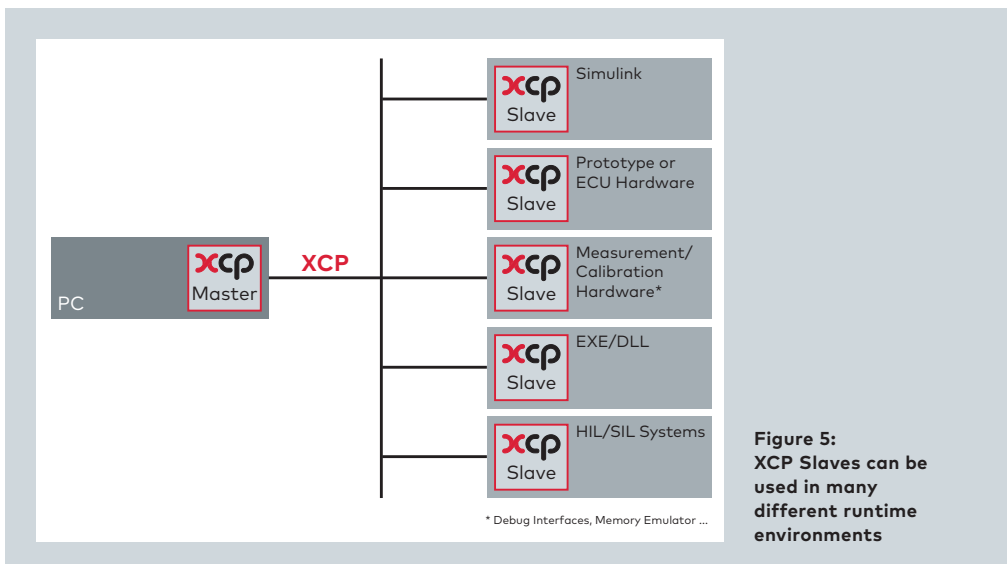

Figure 5:
XCP Slaves can be used in many different runtime environments

How can algorithms be optimized using read and write access to the ECU and what benefits does this offer? To be able to modify individual parameters at runtime in the ECU, there must be access to them. Not every type of memory permits this process. It is only possible to perform a read and write access to memory addresses in RAM (intentionally excluding the EEPROM here). The following is a brief summary of the differences between individual memory technologies: knowledge of them is very important to understanding over the further course of this book.

Memory Fundamentals

Today, flash memories are usually integrated in the microcontroller chips for ECUs and are used for long-term storage of code and data, even without power supply. The special aspect of a flash memory is that read and write access to individual bytes is indeed possible at any time, but writing of new contents can only be done blockwise, usually in rather large blocks.

Flash memories have a limited life, which is specified in terms of a maximum number of erasure cycles (depending on the specific technology the maximum may be up to one million cycles). This is also the maximum number of write cycles, because the memory must always be erased as a block before it can be written again. The reason for this lies in the memory structure: electrons are "pumped" via tunnel diodes. A bit is stored at a memory location as follows: electrons must be transported into the memory location over an electrically insulating layer. Once the electrons are then behind the insulating layer, they form an electric field with their charge, which is interpreted as a 1 when reading the memory location. If there are no electrons behind the layer, the cell information is interpreted as a 0. A 1 can indeed be set in this way, but not a 0. Setting to 0 (= erasing the 1) is performed in a separate erasing routine, in which electrons existing behind the insulating layer are discharged. However, for architectural reasons, such an erasing routine does not just act on single bytes, rather only on the group or block level. Depending on the architecture, blocks of 128 or 256 bytes are usually used. If one wishes to overwrite a byte within such a block, the entire block must first be erased. Then the entire contents of the block can be written back.

When this erasing routine is repeated multiple times, the insulating layer ("Tunnel Oxide Film") can be damaged. This means that the electrons could slowly leak away, changing some of the information from 1 to 0 over the course of time. Therefore, the number of allowable flash cycles is severely limited in an ECU. In the production ECU, it is often only on the order of single digit numbers. This restriction is monitored by the Flash Boot Loader, which uses a counter to keep track of how many flash operations have already been executed. When the specified number is exceeded, the Flash Boot Loader rejects another flash request.

A RAM (Random Access Memory) requires a permanent power supply; otherwise it loses its contents. While flash memory serves the purpose of long-term storage of the application, the RAM is used to buffer computed data and other temporary information. Shutting off the power supply causes the RAM contents to be lost. In contrast to flash memory, it is easy to read and write to RAM.

This fact is clear: if parameters need to be changed at runtime, it must be assured that they are located in RAM. It is really very important to understand this circumstance. That is why we will look at the execution of an application in the ECU based on the following example:

In the application, the y parameters are computed from the sensor values x .

```
// Pseudo-code representation  
a = 5;  
b = 2;  
y = a * x + b;
```

If the application is flashed in the ECU, the controller handles this code as follows after booting: the values of the x parameters correspond to a sensor value. At some time point, the application must therefore poll the sensor value and the value is then stored in a memory location assigned to the x parameters. Since this value always needs to be rewritten at runtime, the memory location can only lie in RAM.

The parameter y is computed. The values a and b , as factor and offset, are included as information in flash memory. They are stored as constants there. The value of y must also be stored in RAM, because once again that is the only place where write access is possible. At precisely which location in RAM the parameters x and y are located, or where a and b lie in flash, is set in the compiler/linker run. This is where objects are allocated to unique addresses. The relationship between object name, data type and address is documented in the linker-map file. The linker-map file is generated by the Linker run and can exist in different formats. Common to all formats, however, is that they contain the object name and address at a minimum.

In the example, if the offset b and factor a depend on the specific vehicle, the values of a and b must be individually adapted to the specific conditions of the vehicle. This means that the algorithm remains as it is, but the parameter values change from vehicle to vehicle.

In the normal operating mode of an ECU, the application runs from the flash memory. It does not permit any write accesses to individual objects. This means that parameter values which are located in the flash area cannot be modified at runtime. If a change to parameter values should be possible during runtime, the parameters to be modified must lie in RAM and not in flash. Now, how do the parameters and their initial values make their way into RAM? How does one solve the problem of needing to modify more parameters than can be simultaneously stored in RAM? These issues lead us to the topic of calibration concepts (see chapter 3).

Summary of XCP fundamentals

Read and write accesses to memory contents are available with the mechanisms of the XCP protocol. The accesses are made in an address-oriented way. Read access enables measurement of parameters from RAM, and write access enables calibration of the parameters in RAM. XCP permits execution of the measurement synchronous to events in the ECU. This ensures that the measured values correlate with one another. With every restart of a measurement, the signals to be measured can be freely selected. For write access, the parameters to be calibrated must be stored in RAM. This requires a calibration concept

This leads to two important questions:

- > How does the user of the XCP protocol know the correct addresses of the measurement and calibration parameters in RAM?
- > What does the calibration concept look like?

The first question is answered in chapter 2 "ECUs description file A2L". The topic of the calibration concept is addressed in chapter 3.

1.1 XCP Protocol Layer

XCP data is exchanged between the Master and Slave in a message-based way. The entire "XCP message frame" is embedded in a frame of the transport layer (in the case of XCP on Ethernet with UDP in a UDP packet). The frame consists of three parts: the XCP header, the XCP packet and the XCP tail.

In the following figure, part of a message is shown in red. It is used to send the current XCP frame. The XCP header and XCP tail depend on the transport protocol.

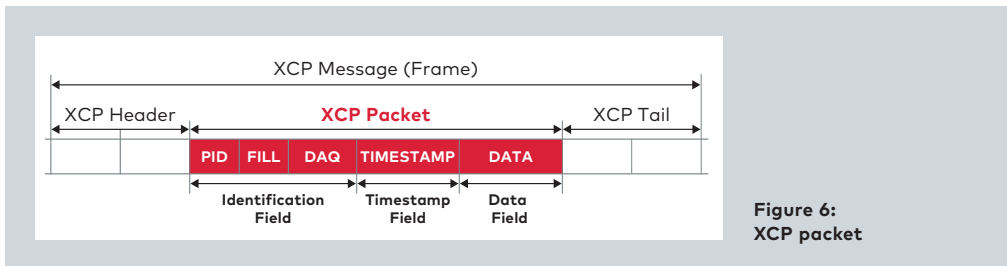

The XCP packet itself is independent of the transport protocol used. It always contains three components: "Identification Field", "Timestamp Field" and the current data field "Data Field". Each Identification Field begins with the Packet Identifier (PID), which identifies the packet.

The following overview shows which PIDs have been defined:

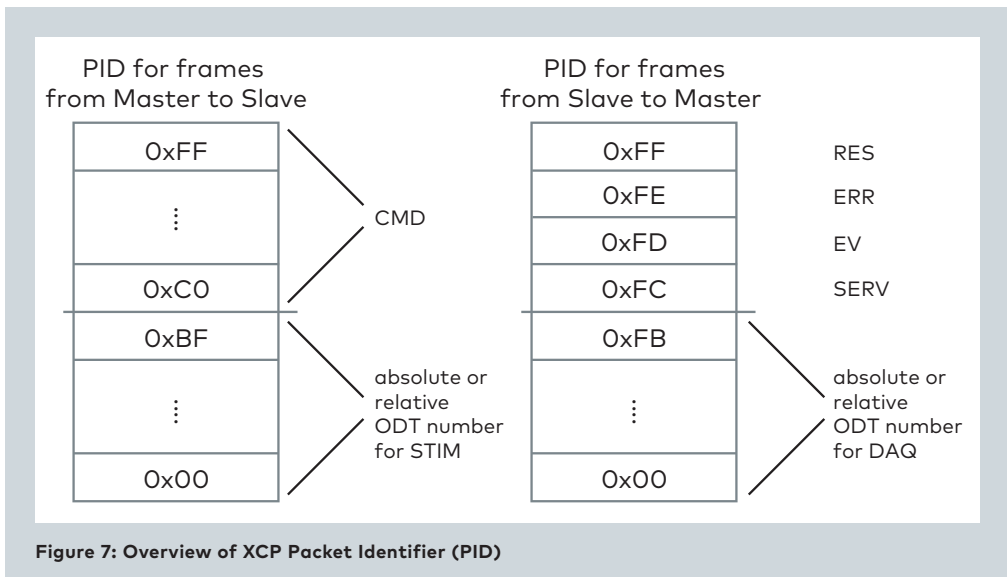

Communication via the XCP packet is subdivided into one area for commands (CTO) and one area for sending synchronous data (DTO).

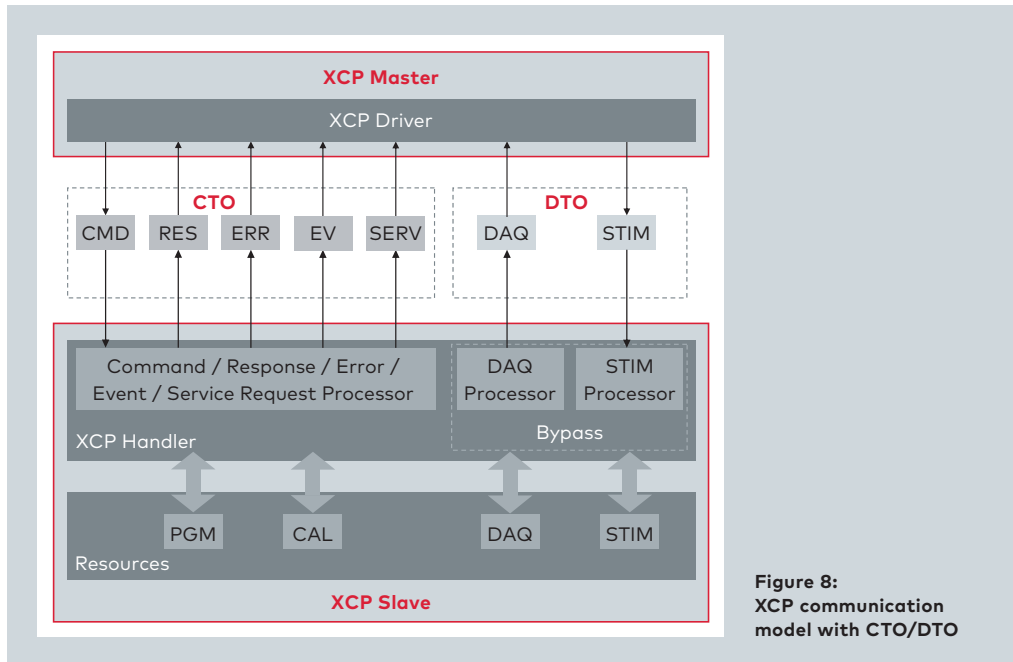

Figure 8:
XCP communication
model with CTO/DTO

The acronyms used here stand for

CMD	Command Packet	sends commands
RES	Command Response Packet	positive response
ERR	Error	negative response
EV	Event Packet	asynchronous event
SERV	Service Request Packet	service request
DAQ	Data AcQuisition	send periodic measured values
STIM	Stimulation	periodic stimulation of the Slave

Commands are exchanged via CTOs (Command Transfer Objects). The Master initiates contact in this way, for example. The Slave must always respond to a CMD with RES or ERR. The other CTO messages are sent asynchronously. The Data Transfer Objects (DTO) are used to exchange synchronous measurement and stimulation data.

1.1.1 Identification Field

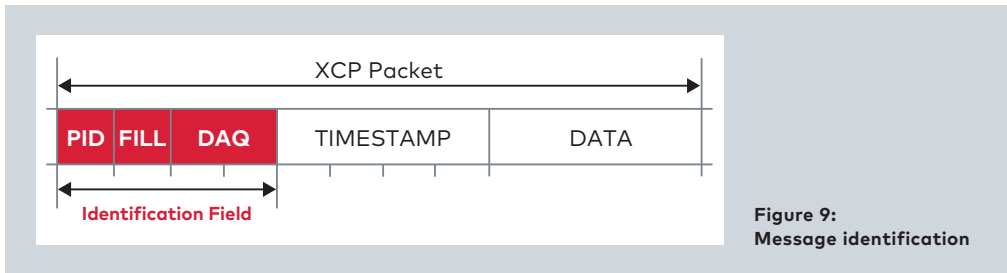

When messages are exchanged, both the Master and Slave must be able to determine which message was sent by the other. This is accomplished in the identification field. That is why each message begins with the Packet Identifier (PID).

In transmitting CTOs, the PID field is fully sufficient to identify a CMD, RES or other CTO packet. In Figure 7, it can be seen that commands from the Master to the Slave utilize a PID from 0xC0 to 0xFF. The XCP Slave responds or informs the Master with PIDs from 0xFC to 0xFF. This results in a unique allocation of the PIDs to the individually sent CTOs.

When DTOs are transmitted, other elements of the identification field are used (see chapter 1.3.4 "XCP Packet Addressing for DAQ and STIM").

1.1.2 Timestamp

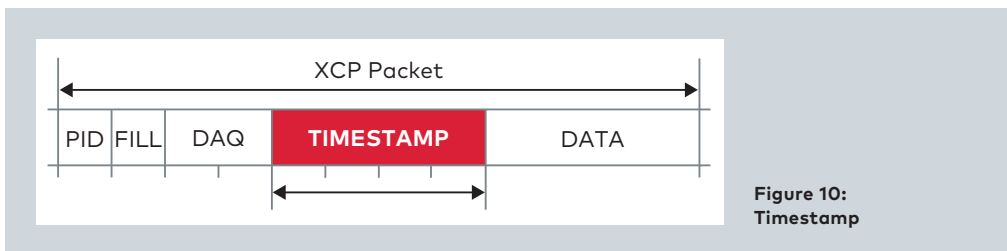

DTO packets use timestamps, but this is not possible in transmission of a CTO message. The Slave uses the timestamp to supply time information with measured values. That is, the Master not only has the measured value, but also the time point at which the measured value was acquired. The amount of time it takes for the measured value to arrive at the Master is no longer important, because the relationship between the measured value and the time point comes directly from the Slave.

Transmission of a timestamp from the Slave is optional. This topic is discussed further in ASAM XCP Part 2 Protocol Layer Specification.

1.1.3 Data Field

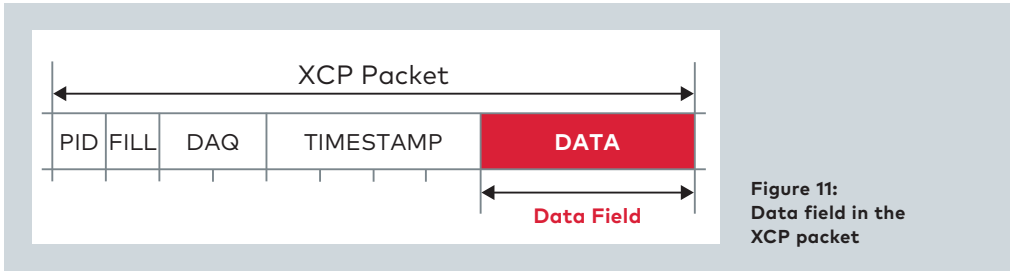

Figure 11:
Data field in the
XCP packet

Finally, the XCP packet also contains the data stored in the data field. In the case of CTO packets, the data field consists of specific parameters for the different commands. DTO packets contain the measured values from the Slave and when STIM data is sent the values from the Master.

1.2 Exchange of CTOs

CTOs are used to transmit both commands from the Master to the Slave and responses from the Slave to the Master.

1.2.1 XCP Command Structure

The Slave receives a command from the Master and must react to it with a positive or negative response. The communication structure is always the same here:

Command (CMD):

Position	Type	Description
0	BYTE	Command Packet Code CMD
1..MAX_CTO-1	BYTE	Command specific Parameters

A unique number is assigned to each command. In addition, other specific parameters may be sent with the command. The maximum number of parameters is defined as MAX_CTO-1 here. MAX_CTO indicates the maximum length of the CTO packets in bytes.

Positive response:

Position	Type	Description
0	BYTE	Command Positive Response Packet Code = RES 0xFF
1..MAX_CTO-1	BYTE	Command specific Parameters

Negative response:

Position	Type	Description
0	BYTE	Error Packet Code = 0xFE
1	BYTE	Error code
2..MAX_CTO-1	BYTE	Command specific Parameters

Specific parameters can be transmitted as supplemental information with negative responses as well and not just with positive responses. One example is when the connection is made between Master and Slave. At the start of a communication between Master and Slave, the Master sends a connect request to the Slave, which in turn must respond positively to produce a continuous point-to-point connection.

Master → Slave: Connect

Slave → Master: Positive Response

Connect command:

Position	Type	Description
0	BYTE	Command Code = 0xFF
1	BYTE	Mode 00 = Normal 01 = user defined

Mode 00 means that the Master wishes XCP communication with the Slave. If the Master uses 0xFF 0x01 when making the connection, the Master is requesting XCP communication with the Slave. Simultaneously, it informs the Slave that it should switch to a specific – user-defined – mode.

Positive response of the Slave:

Position	Type	Description
0	BYTE	Packet ID: 0xFF
1	BYTE	RESOURCE
2	BYTE	COMM_MODE_BASIC
3	BYTE	MAX_CTO, Maximum CTO size [BYTE]
4	WORD	MAX_DTO, Maximum DTO size [BYTE]
6	BYTE	XCP Protocol Layer Version Number (most significant byte only)
7	BYTE	XCP Transport Layer Version Number (most significant byte only)

The positive response of the Slave can assume a somewhat more extensive form. The Slave already sends communication-specific information to the Master when making the connection. RESOURCE, for example, is information that the Slave gives on whether it supports such features as page switching or whether flashing over XCP is possible. With MAX_DTO, the Slave informs the Master of the maximum packet length it supports for transfer of the measured values, etc. You will find details on the parameters in ASAM XCP Part 2 Protocol Layer Specification.

XCP permits three different modes for exchanging commands and reactions between Master and Slave: Standard, Block and Interleaved mode.

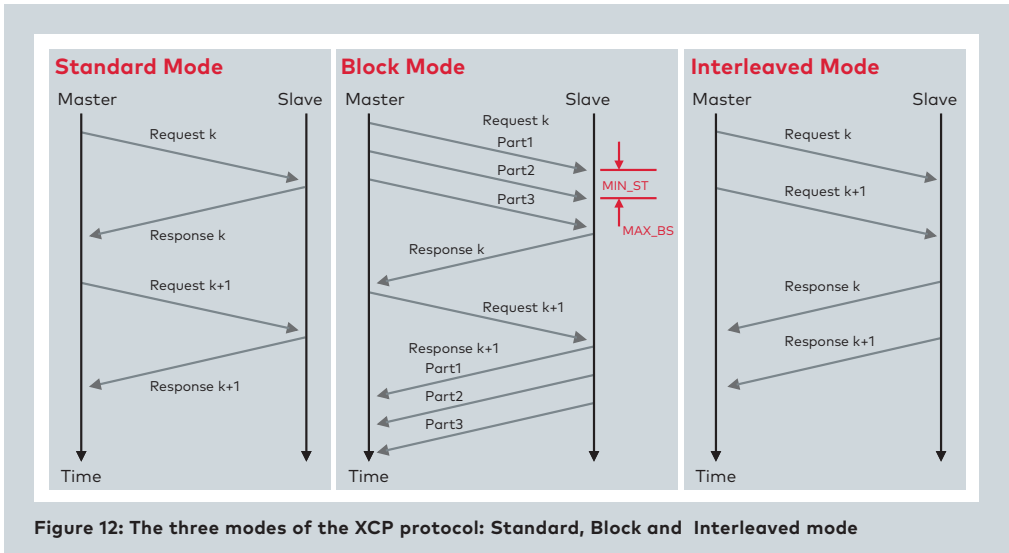

Figure 12: The three modes of the XCP protocol: Standard, Block and Interleaved mode

In the standard communication model, each request to a Slave is followed by a single response. Except with XCP on CAN, it is not permitted for multiple Slaves to react to a command from the Master. Therefore, each XCP message can always be traced back to a unique Slave. This mode is the standard case in communication.

The block transfer mode is optional and saves time in large data transfers (e.g. upload or download operations). Nonetheless, performance issues must be considered in this mode in the direction of the Slave. Therefore, minimum times between two commands (MIN_ST) must be maintained and the total number of commands must be limited to an upper limit MAX_BS. Optionally, the Master can read out these communication settings from the Slave with GET_COMM_MODE_INFO. The aforementioned limitations do not need to be observed in block transfer mode in the direction of the Master, because performance of the PC nearly always suffices to accept the data from a microcontroller.

The interleaved mode is also provided for performance reasons. But this method is also optional and – in contrast to block transfer mode – it has no relevance in practice.

1.2.2 CMD

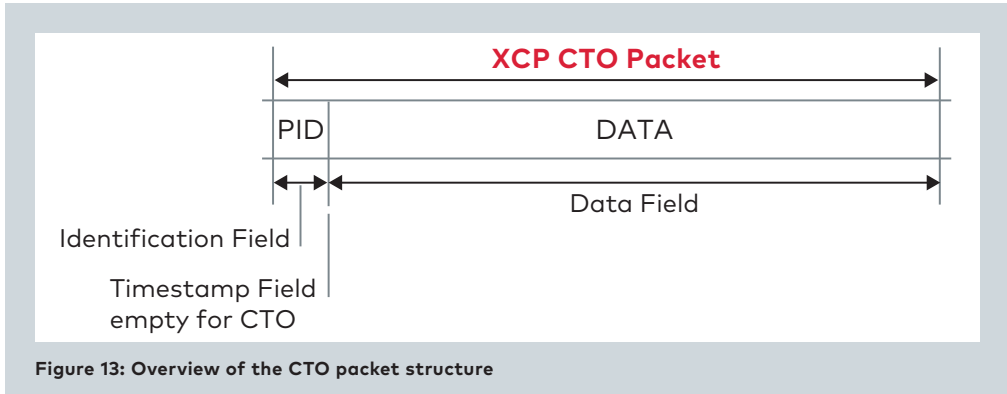

Figure 13: Overview of the CTO packet structure

The Master sends a general request to the Slave over CMD. The PID (Packet Identifier) field contains the identification number of the command. The additional specific parameters are transported in the data field. Then the Master waits for a reaction of the Slave in the form of a RESponse or an ERRor.

XCP is also very scalable in its implementation, so it is not necessary to implement every command. In the A2L file, the available CMDs are listed in what is known as the XCP IF_DATA. If there is a discrepancy between the definition in the A2L file and the implementation in the Slave, the Master can determine, based on the Slave's reaction, that the Slave does not even support the command. If the Master sends a command that is not implemented in the Slave, the Slave must acknowledge with ERR_CMD_UNKNOWN and no further activities are initiated in the Slave. This lets the Master know quickly that an optional command has not been implemented in the Slave.

Some other parameters are included in the commands as well. Please take the precise details from the protocol layer specification in document ASAM XCP Part 2.

The commands are organized in groups: Standard, Calibration, Page, Programming and DAQ measurement commands. If a group is not needed at all, its commands do not need to be implemented. If the group is necessary, certain commands must always be available in the Slave, while others from the group are optional.

The following overview serves as an example. The SET_CAL_PAGE and GET_CAL_PAGE commands in the page switching group are identified as not optional. This means that in an XCP Slave that supports page switching at least these two commands must be implemented. If page switching support is unnecessary in the Slave, these commands do not need to be implemented. The same applies to other commands.

Standard commands:

Command	PID	Optional
CONNECT	0xFF	No
DISCONNECT	0xFE	No
GET_STATUS	0xFD	No
SYNCH	0xFC	No
GET_COMM_MODE_INFO	0xFB	Yes
GET_ID	0xFA	Yes
SET_REQUEST	0xF9	Yes
GET_SEED	0xF8	Yes
UNLOCK	0xF7	Yes
SET_MTA	0xF6	Yes
UPLOAD	0xF5	Yes
SHORT_UPLOAD	0xF4	Yes
BUILD_CHECKSUM	0xF3	Yes
TRANSPORT_LAYER_CMD	0xF2	Yes
USER_CMD	0xF1	Yes

Calibration commands:

Command	PID	Optional
DOWNLOAD	0xF0	No
DOWNLOAD_NEXT	0xEF	Yes
DOWNLOAD_MAX	0xEE	Yes
SHORT_DOWNLOAD	0xED	Yes
MODIFY_BITS	0xEC	Yes

Standard commands:

Command	PID	Optional
SET_CAL_PAGE	0xEB	No
GET_CAL_PAGE	0xEA	No
GET_PAG_PROCESSOR_INFO	0xE9	Yes
GET_SEGMENT_INFO	0xE8	Yes
GET_PAGE_INFO	0xE7	Yes
SET_SEGMENT_MODE	0xE6	Yes
GET_SEGMENT_MODE	0xE5	Yes
COPY_CAL_PAGE	0xE4	Yes

Periodic data exchange – basics:

Command	PID	Optional
SET_DAQ_PTR	0xE2	No
WRITE_DAQ	0xE1	No
SET_DAQ_LIST_MODE	0xE0	No
START_STOP_DAQ_LIST	0xDE	No
START_STOP_SYNCH	0xDD	No
WRITE_DAQ_MULTIPLE	0xC7	Yes
READ_DAQ	0xDB	Yes
GET_DAQ_CLOCK	0xDC	Yes
GET_DAQ_PROCESSOR_INFO	0xDA	Yes
GET_DAQ_RESOLUTION_INFO	0xD9	Yes
GET_DAQ_LIST_INFO	0xD8	Yes
GET_DAQ_EVENT_INFO	0xD7	Yes

Periodic data exchange – static configuration:

Command	PID	Optional
CLEAR_DAQ_LIST	0xE3	No
GET_DAQ_LIST_INFO	0xD8	Yes

Periodic data exchange – dynamic configuration:

Command	PID	Optional
FREE_DAQ	0xD6	Yes
ALLOC_DAQ	0xD5	Yes
ALLOC_ODT	0xD4	Yes
ALLOC_ODT_ENTRY	0xD3	Yes

Flash programming:

Command	PID	Optional
PROGRAM_START	0xD2	No
PROGRAM_CLEAR	0xD1	No
PROGRAM	0xD0	No
PROGRAM_RESET	0xCF	No
GET_PGM_PROCESSOR_INFO	0xCE	Yes
GET_SECTOR_INFO	0xCD	Yes
PROGRAM_PREPARE	0xCC	Yes
PROGRAM_FORMAT	0xCB	Yes
PROGRAM_NEXT	0xCA	Yes
PROGRAM_MAX	0xC9	Yes
PROGRAM_VERIFY	0xC8	Yes

1.2.3 RES

If the Slave is able to successfully comply with a Master's request, it gives a positive acknowledge with RES.

Position	Type	Description
0	BYTE	Packet Identifier = RES 0xFF
1..MAX_CTO-1	BYTE	Command response data

You will find more detailed information on the parameters in ASAM XCP Part 2 Protocol Layer Specification.

1.2.4 ERR

If the request from the Master is unusable, it responds with the error message ERR and an error code.

Position	Type	Description
0	BYTE	Packet Identifier = ERR 0xFE
1	BYTE	Error code
2..MAX_CTO-1	BYTE	Optional error information data

You will find a list of possible error codes in ASAM XCP Part 2 Protocol Layer Specification.

1.2.5 EV

If the Slave wishes to inform the Master of an asynchronous event, an EV can be sent to do this. Its implementation is optional.

Position	Type	Description
0	BYTE	Packet Identifier = EV 0xFD
1	BYTE	Event code
2..MAX_CTO-1	BYTE	Optional event information data

You will find more detailed information on the parameters in ASAM XCP Part 2 Protocol Layer Specification.

Events will be discussed much more in relation to measurements and stimulation. This has nothing to do with the action of the XCP Slave that initiates sending of an EVENT. Rather it involves the Slave reporting a disturbance such as the failure of a specific functionality.

1.2.6 SERV

The Slave can use this mechanism to request that the Master execute a service.

Position	Type	Description
0	BYTE	Packet Identifier = SERV 0xFC
1	BYTE	Service request code
2..MAX_CTO-1	BYTE	Optional service request data

You will find the Service Request Code table in ASAM XCP Part 2 Protocol Layer Specification.

1.2.7 Calibrating Parameters in the Slave

To change a parameter in an XCP Slave, the XCP Master must send the parameter's location as well as the value itself to the Slave.

XCP always defines addresses with five bytes: four for the actual address and one byte for the address extension. Based on a CAN transmission, only seven useful bytes are available for XCP messages. For example, if the calibrator sets a 4-byte value and wants to send both pieces of information in one CAN message, there is insufficient space to do this. Since a total of nine bytes are needed to transmit the address and the new value, the change cannot be transmitted in one CAN message (seven useful bytes). The calibration request is therefore made with two messages from Master to Slave. The Slave must acknowledge both messages and in sum four messages are exchanged.

The following figure shows the communication between Master and Slave, which is necessary to set a parameter value. The actual message is located in the line with the envelope symbol. The interpretation of the message is shown by "expanding" it with the mouse.

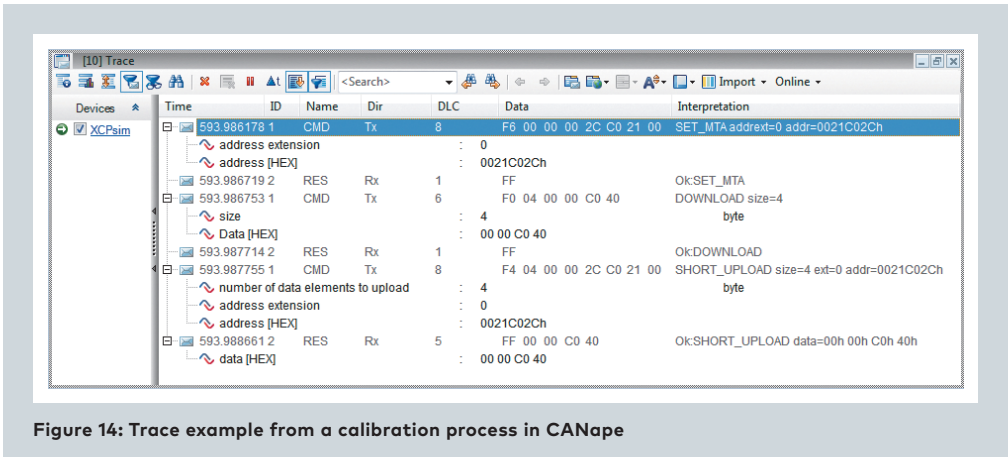

Figure 14: Trace example from a calibration process in CANape

In the first message of the Master (highlighted in blue in Figure 14), the Master sends the command SET_MTA to the Slave with the address to which a new value should be written. In the second message, the Slave gives a positive acknowledge to the command with Ok:SET_MTA.

The third message DOWNLOAD transmits the hex value as well as the valid number of bytes. In this example, the valid number of bytes is four, because it is a float value. The Slave gives another positive acknowledge in the fourth message.

This completes the current calibration process. In the Trace display, you can recognize a terminating SHORT_UPLOAD – a special aspect of CANape, the measurement and calibration tool from Vector. To make sure that the calibration was performed successfully, the value is read out again after the process and the display is updated with the read-out value. This lets the user directly recognize whether the calibration command was implemented. This command also gets a positive acknowledge with Ok:SHORT_UPLOAD.

When the parameter changes in the ECU's RAM, the application processes the new value. A reboot of the ECU, however, would lead to erasure of the value and overwriting of the value in RAM with the original value from the flash (see chapter 3 "Calibration Concepts"). So, how can the modified parameter set be permanently saved?

Essentially, there are two possibilities:

A) Save the parameters in the ECU

The changed data in RAM could for example be saved in the ECU's EEPROM: either automatically when ramping down the ECU, or manually by the user. A prerequisite is that the data can be stored in a nonvolatile memory of the Slave. In an ECU, this would be the EEPROM or flash. ECUs with thousands of parameters, however, are seldom able to provide so much unused EEPROM memory space, so this method is rare.

Another possibility is to write the RAM parameters back into the ECU's flash memory. This method is relatively complex. A flash memory must first be erased before it can be rewritten. This, in turn, can only be done as a block. Consequently, it is not simply a matter of writing back individual bytes. You will find more on this topic in chapter 3 "Calibration Concepts".

B) Save the parameters in the form of a file on the PC

It is much more common to store the parameters on the PC. All parameters – or subsets of them – are stored in the form of a file. Different formats are available for this; the simplest case is that of an ASCII text file, which only contains the name of the object and its value. Other formats also permit saving other information, such as findings about the maturity level of the parameter or the history of revisions.

Scenario: After finishing his or her work, the calibrator wishes to enjoy a free evening. So, the calibrator saves the executed changes in the ECU's RAM in the form of a parameter set file on a PC. The next day, the calibrator wants to continue working where he or she left off. The calibrator starts the ECU. Upon booting, the parameters are initialized in RAM. However, the ECU does this using values stored in flash. This means that the changes of the previous day are no longer available in the ECU. To now continue where work was left off on the previous day, the calibrator transfers the contents of the parameter set file to the ECU's RAM by XCP using the DOWNLOAD command.

Time	ID	Name	Dir	DLC	Data	Interpretation
444.134168	1	CMD	Tx	8	F6 00 00 00 60 A3 21 00	SET_MTA addr=0 addr=0021A360h
444.134293	2	RES	Rx	1	FF	OkSET_MTA
444.134299	1	CMD	Tx	8	F0 06 00 00 00 00 00 00	DOWNLOAD size=6
444.134719	2	RES	Rx	1	FF	OkDOWNLOAD
444.134726	1	CMD	Tx	8	F0 06 00 00 00 00 00 00	DOWNLOAD size=6
444.135159	2	RES	Rx	1	FF	OkDOWNLOAD
444.135165	1	CMD	Tx	8	F0 06 00 00 00 00 00 00	DOWNLOAD size=6
444.135567	2	RES	Rx	1	FF	OkDOWNLOAD
444.135573	1	CMD	Tx	8	F0 06 00 00 00 00 00 00	DOWNLOAD size=6
444.136062	2	RES	Rx	1	FF	OkDOWNLOAD
444.136084	1	CMD	Tx	8	F0 06 00 00 00 00 00 00	DOWNLOAD size=6
444.136562	2	RES	Rx	1	FF	OkDOWNLOAD
444.136575	1	CMD	Tx	8	F0 06 00 00 00 00 00 00	DOWNLOAD size=6
444.137019	2	RES	Rx	1	FF	OkDOWNLOAD

Figure 15: Transfer of a parameter set file to an ECU's RAM

Saving parameter set file in hex files and flashing

Flashing an ECU is another way to change the parameters in flash. They are then written to RAM as new parameters when the ECU is booted. A parameter set file can also be transferred to a C or H file and be made into the new flash file with another compiler/linker run. However, depending on the parameters of the code, the process of generating a flashable hex file could take a considerable amount of time. In addition, the calibrator might not have any ECU source code – depending on the work process. That would prevent this method from being available to the calibrator.

As an alternative, the calibrator can copy the parameter set file into the existing flash file.

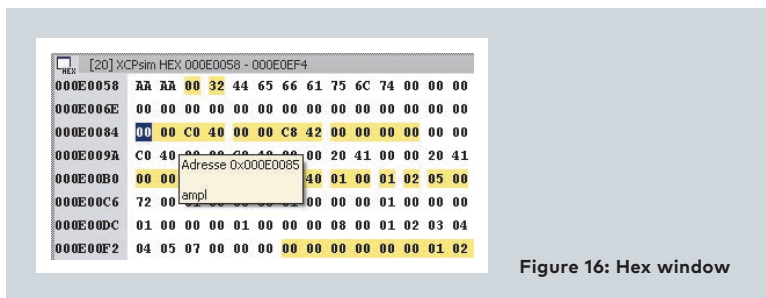

Figure 16: Hex window

In the flash file, there is a hex file that contains both the addresses and the values. Now a parameter file can be copied to a hex file. To do this, CANape takes the address and the value from the parameter set file and updates the parameter value at the relevant location in the hex file. This results in a new hex file, which contains the changed parameter values. However, this Hex file must now possibly run through further process steps to obtain a flashable file. One recurring problem here is the checksums, which the ECU checks to determine whether it received the data correctly. If the flashable file exists, it can be flashed in the ECU and after the reboot the new parameter values are available in the ECU.

1.3 Exchanging DTOs – Synchronous Data Exchange

As depicted in Figure 8, DTOs (Data Transfer Objects) are available for exchanging synchronous measurement and calibration data. Data from the Slave are sent to the Master by DAQ – synchronous to internal events. This communication is subdivided into two phases: In an initialization phase, the Master communicates to the Slave which data the Slave should send for different events. After this phase, the Master initiates the measurement in the Slave and the actual measurement phase begins. From this point in time, the Slave sends the desired data to the Master, which only listens until it sends a “measurement stop” to the Slave. Triggering of measurement data acquisition and transmission is controlled by events in the ECU.

The Master sends data to the Slave by STIM. This communication also consists of two phases:

In the initialization phase, the Master communicates to the Slave which data it will send to the Slave. After this phase, the Master sends the data to the Slave and the STIM processor saves the data. As soon as a related STIM event is triggered in the Slave, the data is transferred to the application memory.

1.3.1 Measurement Methods: Polling versus DAQ

Before explaining how event-synchronous, correlated data is measured from a Slave, here is a brief description of another measurement method known as Polling. It is not based on DTOs, but on CTOs instead. Actually, this topic should be explained in a separate chapter, but a description of polling lets us derive, in a very elegant way, the necessity of DTO-based measurement, so a minor side discussion at this point makes sense.

The Master can use the SHORT_UPLOAD command to request the value of a measurement parameter from the Slave. This is referred to as polling. This is the simplest case of a measurement: sending the measured value of a measurement parameter at the time at which the SHORT_UPLOAD command has been received and executed.

In the following example, the measurement parameter "Triangle" is measured from the Slave:

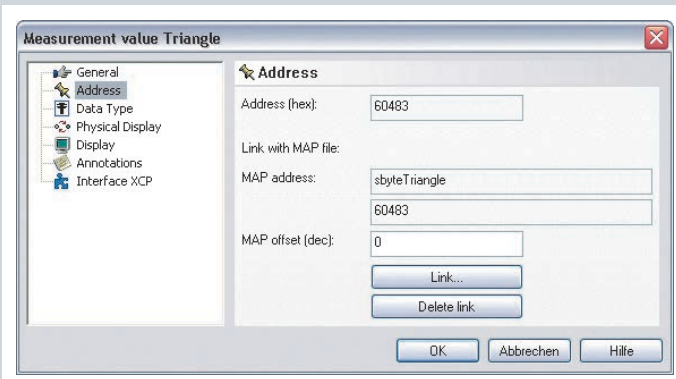

Figure 17:
Address information
of the parameter
"Triangle" from the
A2L file

The address 0x60483 is expressed as an address with five bytes in the CAN frame: one byte for the address extension and four bytes for the actual address.

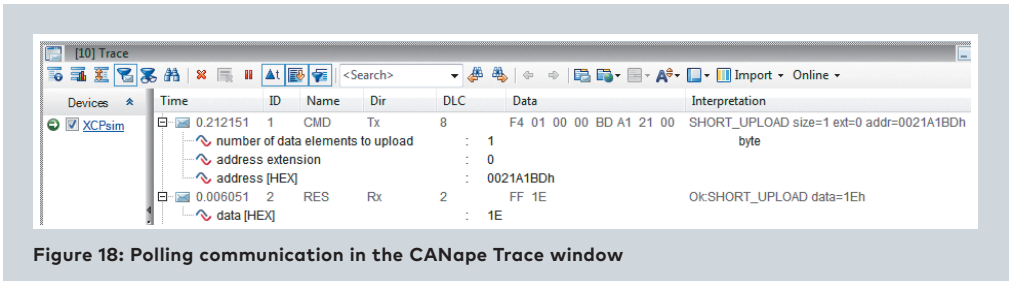

Figure 18: Polling communication in the CANape Trace window

The XCP specification sets a requirement for polling: that the value of each measurement parameter must be polled individually. For each value to be measured via polling, two messages must go over the bus: the Master's request to the Slave and the Slave's response to the Master.

Besides this additional bus load, there is another disadvantage of the polling method: When polling multiple data values, the user normally wants the data to correlate to one another. However, multiple values that are measured sequentially with polling do not necessarily stand in correlation to one another, i.e. they might not originate from the same ECU computing cycle.

This limits the suitability of polling for measurement, because it produces unnecessarily high data traffic and the measured values are not evaluated in relation to the process flows in the ECU.

So, an optimized measurement must solve two tasks:

- > Bandwidth optimization during the measurement
- > Assurance of data correlation

This task is handled by the already mentioned DAQ method. DAQ stands for Data Acquisition and it is implemented by sending DTOs (Data Transfer Objects) from the Slave to the Master.

1.3.2 DAQ Measurement Method

The DAQ method solves the two problems of polling as follows:

- > The correlation of measured values is achieved by coupling the acquisition of measured values to the events in the ECU. The measured values are not acquired and transferred until it has been assured that all computations have been completed.
- > To reduce bus load, the measurement process is subdivided into two phases: In a configuration phase, the Master communicates which values it is interested in to the Slave and the second phase just involves transferring the measured values of the Slave to the Master.

How can the acquisition of measured values now be coupled to processes in the ECU? Figure 19 shows the relationship between calculation cycles in the ECU and the changes in parameters X and Y.

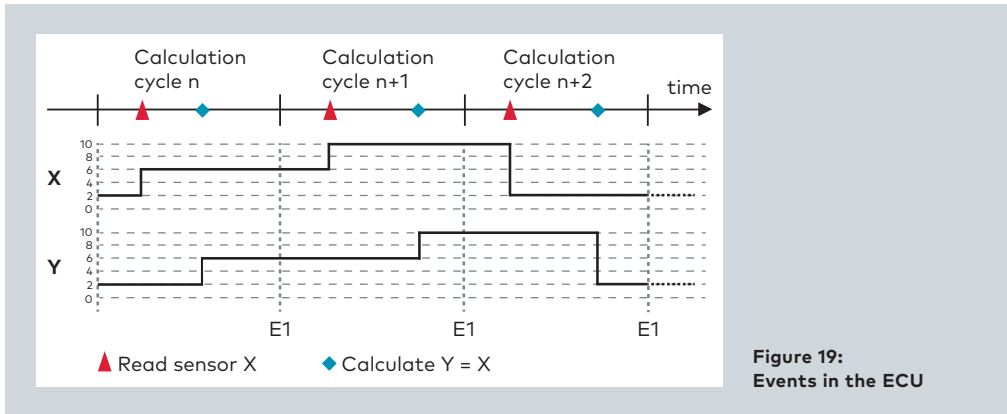

Let's have a look at the sequence in the ECU: When event E1 (= end of computation cycle) is reached, then all parameters have been acquired and calculations have been made. This means that all values must match one another and correlate at this time point. This means that we use an event-synchronous measurement method. This is precisely what is implemented with the help of the DAQ mechanism: When the algorithm in the Slave reaches the "Computational cycle completed" event, the XCP Slave collects the values of the measurement parameters, saves them in a buffer and sends them to the Master. This assumes that the Slave knows which parameters should be measured for which event.

An event does not absolutely have to be a cyclic, time-equidistant event, rather in the case of an engine controller, for example, it might be angle-synchronous. This makes the time interval between two events dependent on the engine rpm. A singular event, such as activation of a switch by the driver, is also an event that is not by any means equidistant in time.

The user selects the signals. Besides the actual measurement object, the user must select the underlying event for the measurement parameters. The events as well as the possible assignments of the measurement objects to the events must be stored in the A2L file.

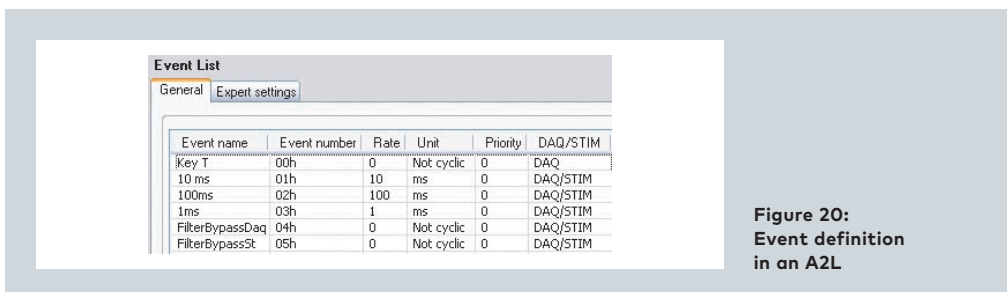

In the normal case, it does not make any sense to be able to simultaneously assign a measured value to multiple events. Generally, a parameter is only modified within a single cycle (e.g. only at 10-ms intervals) and not in multiple cycles (e.g. at 10-ms and 100-ms intervals).

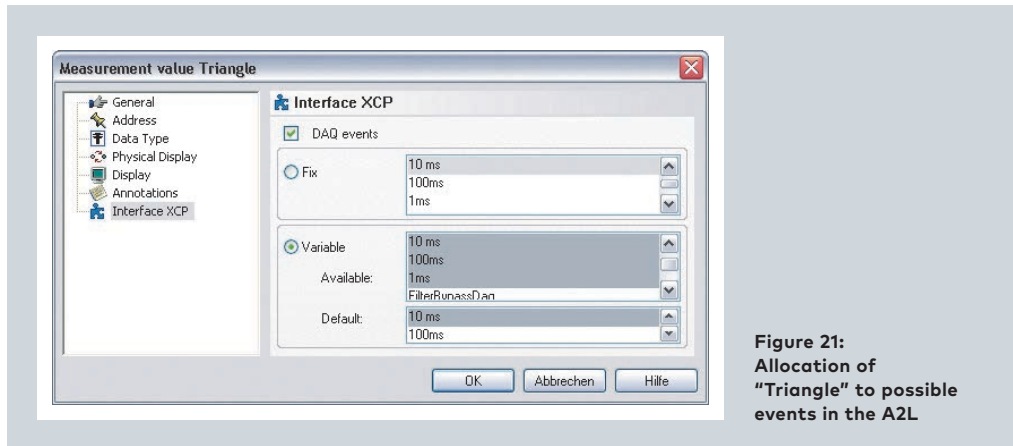

Figure 21:
Allocation of
"Triangle" to possible
events in the A2L

Figure 21 shows that the "Triangle" parameter can in principle be measured with the 1 ms, 10 ms and 100 ms events. The default setting is 10 ms.

Measurement parameters are allocated to events in the ECU during measurement configuration by the user.

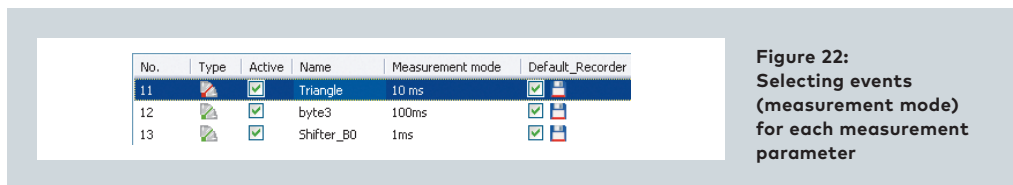

Figure 22:
Selecting events
(measurement mode)
for each measurement
parameter

After configuring the measured signals, the user starts the measurement. The XCP Master lists the desired measurement parameters in what are known as DAQ lists. In these lists, the measured signals are each allocated to selected events. This configuration information is sent to the Slave before the actual start of measurement. Then the Slave knows which addresses it should read out and transmit when an event occurs. This distribution of the measurement into a configuration phase and a measurement phase was already mentioned at the very beginning of this chapter.

This solves both problems that occur in polling: bandwidth is used optimally, because the Master no longer needs to poll each value individually during the measurement and the measured values correlate with one another.

Time	Id...	Name	Dir	DLC	Data	Interpretation
-0.460712	555	RES	Rx	2	FF 00	Ok::START_STOP_DAQ_LIST firstPid=00h
-0.460696	554	CMD	Tx	8	E0 00 01 00 02 00 01 00	SET_DAQ_LIST_MODE mode=00h daq=1 event=2 prescaler=1 priority=0
-0.460693	555	RES	Rx	1	FF	Ok::SET_DAQ_LIST_MODE
-0.460678	554	CMD	Tx	4	DE 02 01 00	START_STOP_DAQ_LIST mode=02h daq=1
-0.460675	555	RES	Rx	2	FF 02	Ok::START_STOP_DAQ_LIST firstPid=02h
-0.217593						Measurement started:
0.002529	554	CMD	Tx	2	DD 01	START_STOP_SYNCH mode=01h
0.002560	555	RES	Rx	1	FF	Ok::START_STOP_SYNCH
0.002761	555	DAQ	Rx	8	00 00 00 03 64 00 00 54	Data
0.002788	555	DAQ	Rx	4	01 00 10 63	Data
0.014976	555	DAQ	Rx	8	00 00 00 03 64 00 00 55	Data
0.014999	555	DAQ	Rx	4	01 00 20 63	Data
0.026508	555	DAQ	Rx	8	00 00 00 03 64 00 00 56	Data
0.026534	555	DAQ	Rx	4	01 00 40 63	Data
0.026544	555	DAQ	Rx	8	00 01 00 00 00 00 00 00	Data
0.026554	555	DAQ	Rx	8	01 01 01 02 00 00 00 00	Data
0.026564	555	DAQ	Rx	8	02 01 00 00 02 03 00 00	Data
0.026573	555	DAQ	Rx	8	03 01 00 00 01 01 03 03	Data

Figure 23: Excerpt from the CANape Trace window of a DAQ measurement

Figure 23 illustrates an example of command-response communication (color highlighting) between Master and Slave (overall it is significantly more extensive and is only shown in part here for reasons of space). This involves transmitting the DAQ configuration to the Slave. Afterwards, the measurement start is triggered and the Slave sends the requested values while the Master just listens.

Until now, the selection of a signal was described based on its name and allocation to a measurement event. But how exactly is the configuration transferred to the XCP Slave?

Let us look at the problem from the perspective of memory structure in the ECU: The user has selected signals and wishes to measure them. So that sending a signal value does not require the use of an entire message, the signals from the Slave are combined into message packets. The Slave does not create this definition of the combination independently, or else the Master would not be able to interpret the data when it received the messages. Therefore, the Slave receives an instruction from the Master describing how it should distribute the values to the messages.

The sequence in which the Slave should assemble the bytes into messages is defined in what are known as Object Description Tables (ODTs). The address and object length are important to uniquely identify a measurement object. An ODT provides the allocations of RAM contents from the Slave to assemble a message on the bus. According to the communication model, this message is transmitted as a DAQ DTO (Data Transfer Object).

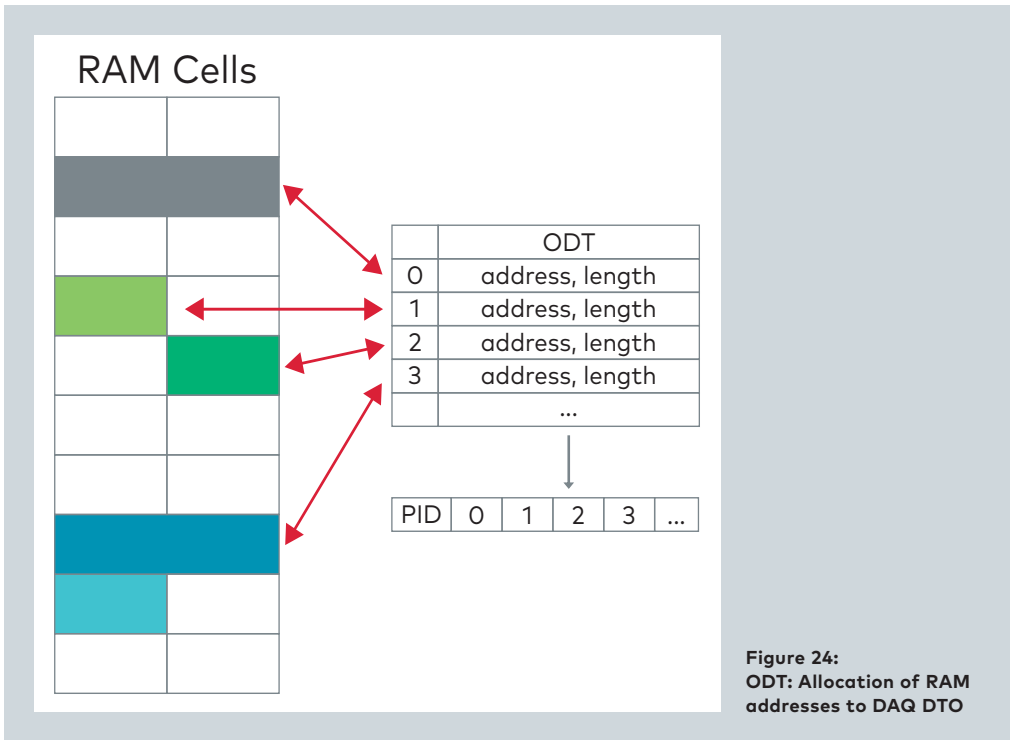

Figure 24:
ODT: Allocation of RAM
addresses to DAQ DTO

Stated more precisely, an entry in an ODT list references a memory area in RAM by the address and length of the object.

After receiving the measurement start command, at some point an event occurs that is associated with a measurement. The XCP Slave begins to acquire the data. It combines the individual objects into packets and sends them on the bus. The Master reads the bus message and can interpret the individual data, because it has defined the allocation of individual objects to packets itself and therefore it knows their relationships.

However, each packet has a maximum number of useful bytes, which depends on the transport medium that is used. In the case of CAN, this amounts to seven bytes. If more data needs to be measured, an ODT is no longer sufficient. If two or more ODTs need to be used to transmit the measured values, then the Slave must be able to copy the data into the correct ODT and the Master must be able to uniquely identify the received ODTs. If multiple measurement intervals of the ECU are used, the relationship between ODT and measurement interval must also be uniquely identifiable.

The ODTs are combined into DAQ lists in the XCP protocol. Each DAQ list contains a number of ODTs and is assigned to an event.

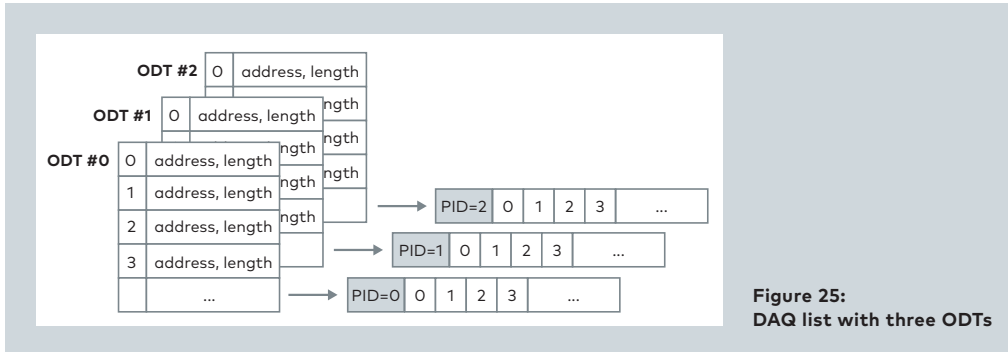

Figure 25:
DAQ list with three ODTs

For example, if the user uses two measurement intervals (= two different events in the ECU), then two DAQ lists are used as well. One DAQ list is needed per event used. Each DAQ list contains the entries related to the ODTs and each ODT contains references to the values in the RAM cells.

It is also possible for the Slave to transfer time information. A DAQ list represents the values belonging to a specific time event. Before these values in the Slave are recorded, the point in time of the event is noted and transferred within the first ODT. The timestamp is implemented using a counter. The time interval at which the counter is incremented is specified in the A2L.

DAQ lists are subdivided into the types: static, predefined and dynamic.

Static DAQ lists:

If the DAQ lists and ODT tables are permanently defined in the ECU, as is familiar from CCP, they are referred to as static DAQ lists. There is no definition of which measurement parameters exist in the ODT lists, rather only the framework that can be filled (in contrast to this, see predefined DAQ lists).

In static DAQ lists, the definitions are set in the ECU code and are described in the A2L. Figure 26 shows an excerpt of an A2L, in which static DAQ lists are defined:

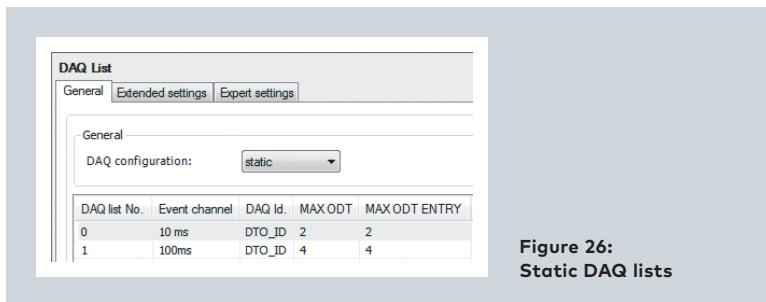

Figure 26:
Static DAQ lists

In the above example, there is a DAQ list with the number 0, which is allocated to a 10-ms event and can carry a maximum of two ODTs. The DAQ list with the number 1 has four ODTs and is linked to the 100 ms event.

The A2L matches the contents of the ECU. In the case of static DAQ lists, the number of DAQ lists and the ODT lists they each contain are defined with the download of the application into the ECU. If the user now attempts to measure more signals with an event than fit in the allocated DAQ list, the Slave in the ECU will not be able to fulfill the requirements and the configuration attempt is terminated with an error. It does not matter that the other DAQ list is still fully available and therefore actually still has transmission capacity.

Predefined DAQ lists:

Entirely predefined DAQ lists can also be set up in the ECU. However, this method is practically never used in ECUs due to the lack of flexibility for the user. It is different for analog measurement systems which transmit their data by XCP: Flexibility is unnecessary here, since the physical structure of the measurement system remains the same over its life.

Dynamic DAQ lists:

A special aspect of the XCP protocol are the dynamic DAQ lists. It is not the absolute parameters of the DAQ and ODT lists that are permanently defined in the ECU code here, but just the parameters of the memory area that can be used for the DAQ lists. The advantage is that the measurement tool has more latitude in putting together the DAQ lists and it can manage the structure of the DAQ lists dynamically.

Various functions especially designed for this dynamic management are available in XCP such as `ALLOC_ODT` which the Master can use to define the structure of a DAQ list in the Slave.

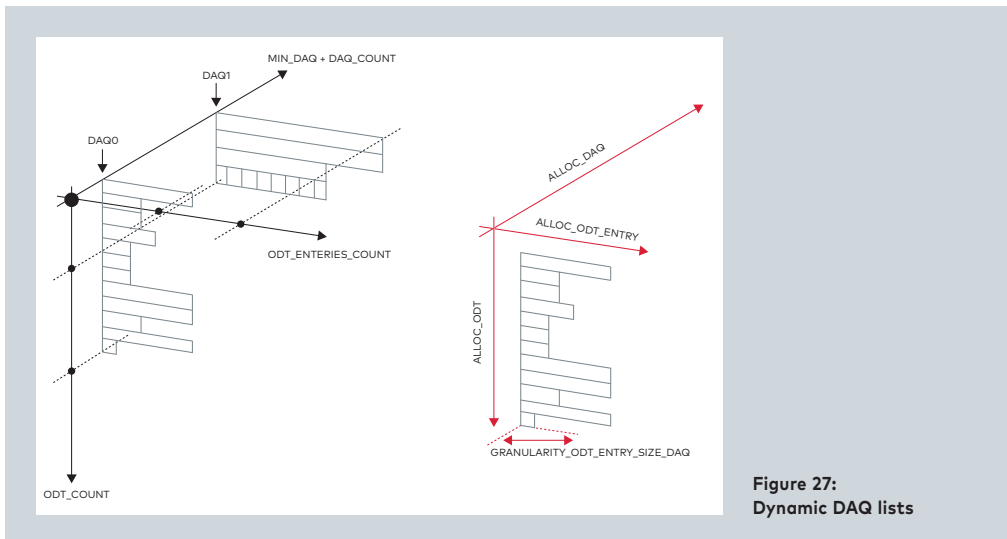

In putting together the DAQ lists, the Master must be able to distinguish whether dynamic or static DAQ lists are being used, how the parameters and structures of the DAQ lists look, etc.

1.3.3 STIM Calibration Method

The XCP calibration method was already introduced in the chapter about exchanging CTOs. This type of calibration exists in every XCP driver and forms the basis for calibrating objects in the ECU. However, no synchronization exists between sending a calibration command and an event in the ECU.

In contrast to this, the use of STIM is not based on exchanging CTOs, rather on the use of DTOs with communication that is synchronized to an event in the Slave. The Master must therefore know to which events in the Slave it can even synchronize at all. This information must also exist in the A2L.

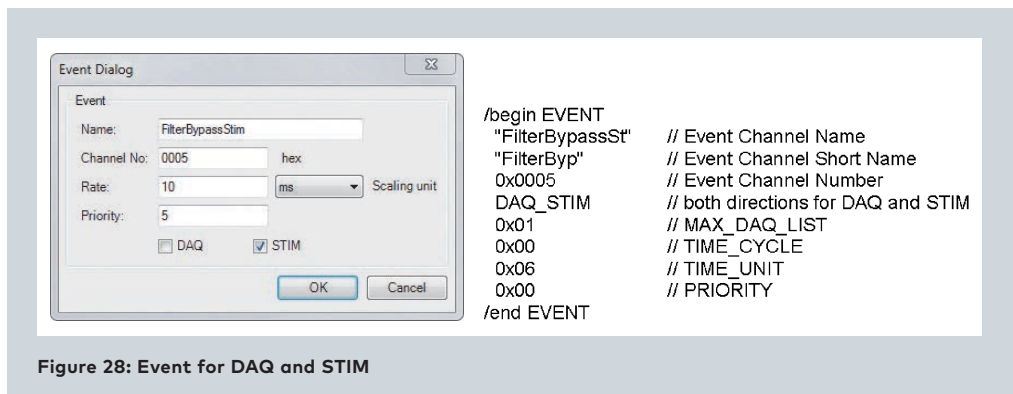

Figure 28: Event for DAQ and STIM

If the Master sends data to the Slave by STIM, the XCP Slave must be informed of the location in the packets at which the calibration parameters can be found. The same mechanisms are used here as are used for the DAQ lists.

1.3.4 XCP Packet Addressing for DAQ and STIM

Addressing of the XCP packets was already discussed at the beginning of this chapter. Now that the concepts of DAQ, ODT and STIM have been introduced, XCP packet addressing will be presented in greater detail.

During transmission of CTOs, the use of a PID is fully sufficient to uniquely identify a packet; however, this is no longer sufficient for transmitting measured values. The following figure offers an overview of the possible addressing that could occur with the DTOs:

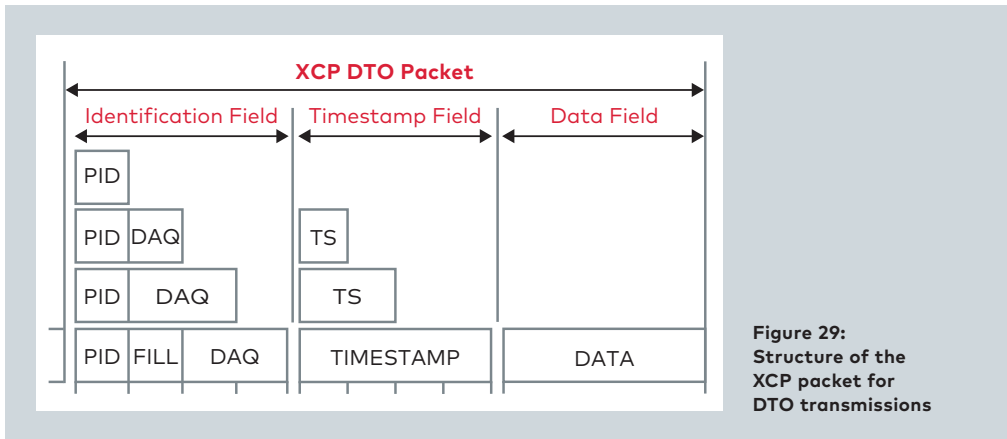

Figure 29:
Structure of the
XCP packet for
DTO transmissions

Transmission type: "absolute ODT numbers"

Absolute means that the ODT numbers are unique throughout the entire communication – i.e. across all DAQ lists. In turn, this means that the use of absolute ODT numbers assumes a transformation step that utilizes a so-called "FIRST_PID for the DAQ list.

If a DAQ list starts with the PID j , then the PID of the first packet has the value j , the second packet has the PID value $j + 1$, the third packet has the PID value $j + 2$, etc. Naturally, the Slave must ensure here that the sum of FIRST_PID + relative ODT number remains below the PID of the next DAQ list.

DAQ-list: $0 \leq \text{PID} \leq k$

DAQ-list: $k + 1 \leq \text{PID} \leq m$

DAQ-list: $m + 1 \leq \text{PID} \leq n$

etc.

In this case, the identification field is very simple:

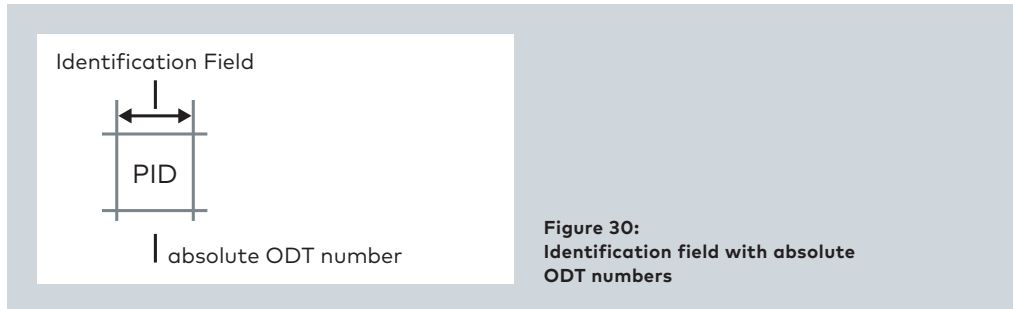

Transmission type: "relative ODT numbers and absolute DAQ lists numbers"

In this case, both the DAQ lists number and the ODT number can be transmitted in the Identification Field. However, there is still space left over in the number of bytes that is available for the information:

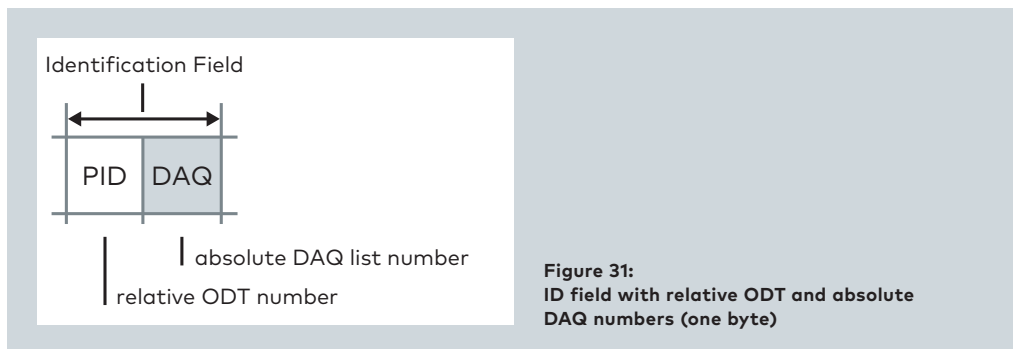

In the figure, one byte is available for the DAQ number and one byte for the ODT number.

The maximum number of DAQ lists can be transmitted using two bytes:

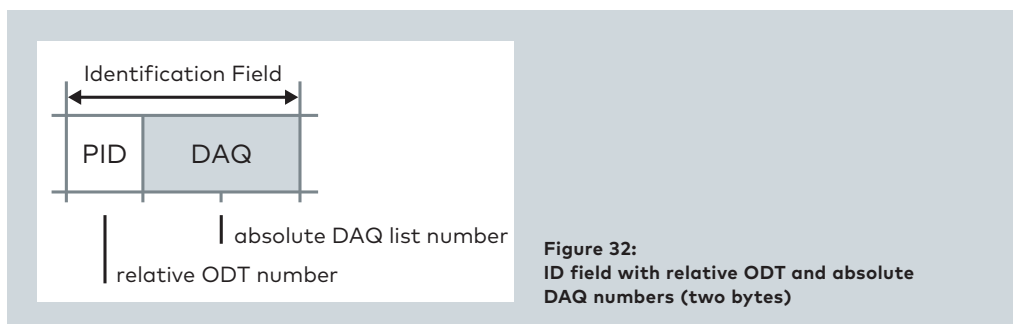

If it is not possible to send three bytes, it is also possible to work with four bytes by using a fill byte:

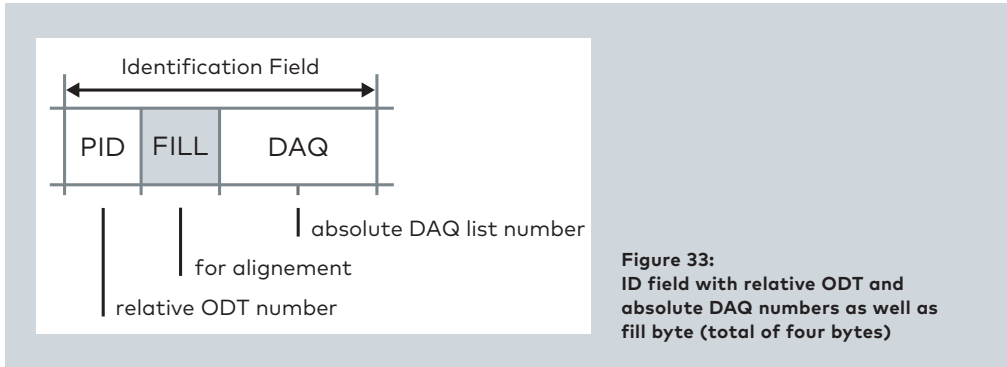

Figure 33:
ID field with relative ODT and absolute DAQ numbers as well as fill byte (total of four bytes)

How does the XCP Master now learn which method the Slave is using? First, by the entry in the A2L and second by the request to the Slave to determine which communication version it has implemented.

The response to the `GET_DAQ_PROCESSOR_INFO` request also sets the `DAQ_KEY_BYTE` that the Slave uses to inform the Master which transmission type is being used. If not only DAQ is being used, but also STIM, the Master must use the same method for STIM that the Slave uses for DAQ.

1.3.5 Bypassing = DAQ + STIM

Bypassing can be implemented by joint use of DAQ and STIM (see Figure 8) and it represents a special form of a rapid prototyping solution. For a deeper understanding, however, further details are necessary, so this method is not explained until chapter 4.5 "Bypassing".

1.3.6. Time Correlation and Synchronization

Various mechanisms are available to the Master for correlating the timestamp of the measurement data of a Slave to the timestamps of other measurement data. In the simplest form of a Slave implementation, the Slave features a clock and can access its value at any time. The DAQ timestamps sent by the XCP Slave are based on this clock. Here, the Slave transfers the time information in the first ODT of each DAQ event. The Slave retrieves the timestamp at the point in time at which the event was initiated and at which it copies the measurement data from RAM.

The correlation of this clock to other clocks is unknown to the Master, as the DAQ messages require an undefined amount of time to reach the Master from the Slave. The clocks can be correlated using the `GET_DAQ_CLOCK` command. Before the start of measurement, and usually at regular intervals, the Master sends the `GET_DAQ_CLOCK` command and the

Slave responds with the current value of the Slave clock. Since the Master knows the point in time at which it sent the command, it can calculate a time offset between the Master clock and the Slave clock using the timestamp of the Slave and the point in time the command was sent.

Naturally, this method is also afflicted with inaccuracies if the run time of the GET_DAQ_CLOCK command is not precisely defined or the point in time at which the clocks are read in the Master and Slave cannot be determined precisely when sending/receiving the command. This is why version 1.3 of the XCP specification provides improved methods enabling correlation of the Master and Slave clocks with a precision of just a few microseconds.

1.3.6.1 Multicast

For better correlation of the clocks of multiple Slaves to one another, the Master reads the clocks of multiple Slaves at the same time. For this purpose, the Master sends a command to all Slaves which are accessible using the same transport medium. Each Slave records the point in time at which it receives the command and transfers the value to the Master. To achieve maximum precision, two requirements must be fulfilled to the greatest degree possible:

On the one hand, the Slave implementation should ensure (as in the past) that the recording of the timestamp is initiated as soon as possible upon receipt of the command. On the other hand, the latency times between the Slaves and the Master should be the same to the greatest degree possible.

The GET_DAQ_CLOCK_MULTICAST command is available for this purpose. The Slave responds with an EV_TIME_SYNC message, in which the timestamp is transferred.

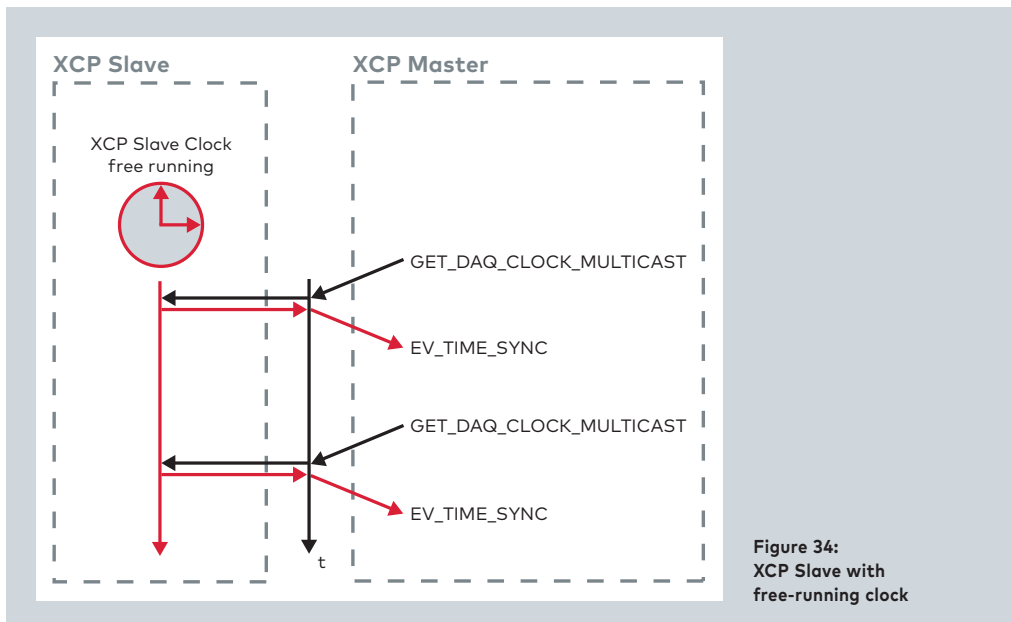

Figure 34:
XCP Slave with
free-running clock

1.3.6.2. Grandmaster Clock

A further solution involves the time of the Slave already being synchronized/coordinated with another clock, the so-called grandmaster clock.

First, an explanation of the terms "synchronized" and "coordinated":

Stated simply, two clocks are synchronized with one another if they supply the identical timestamp when they are read at the same time.

In contrast, clocks which are coordinated to one another do not necessarily need to supply the same timestamp. In both clocks, 1 second is exactly the same length.

IEEE 1588 with PTP (Precision Time Protocol) is used. In the first step, the XCP Master must know whether the Slave is linked to an external clock. As there can be more than one grandmaster clock in an overall system, information on the exact clock to which the Slave is linked must be available to the XCP Master.

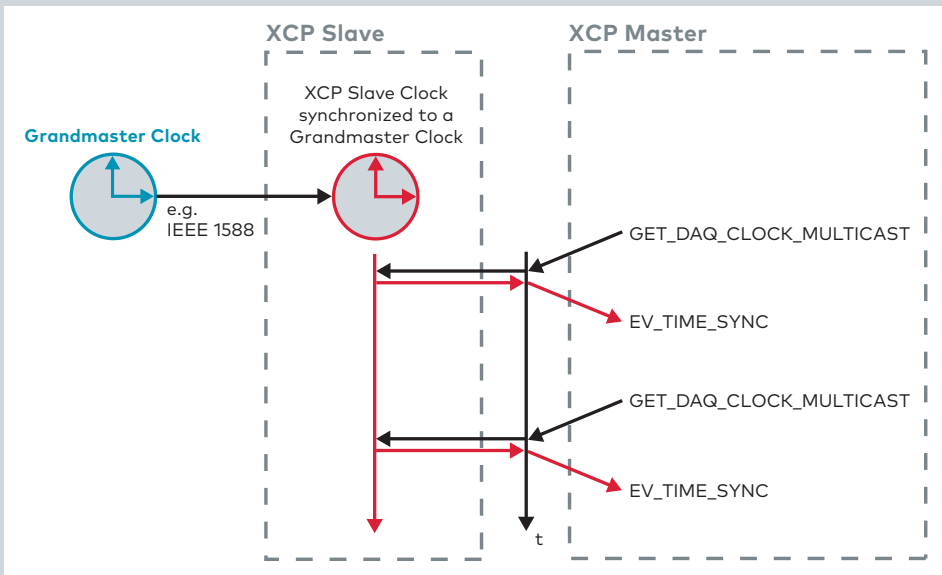

Figure 35: The clock of the XCP Slave is synchronized with the grandmaster clock

The XCP standard supports additional scenarios which can only briefly be sketched out here briefly. Further details can be found in the XCP specifications.

- > Should it be possible to coordinate the XCP Slave clock with the external clock, but not synchronize them, there will be an offset between the grandmaster clock and the Slave clock. The XCP Master can request the details from the Slave using the `TIME_CORRELATION_PROPERTIES` command.
- > The free-running clock of the Slave cannot be synchronized with a grandmaster clock, but there is another clock in the Slave, e.g. a clock synchronized with the grandmaster clock in the Ethernet PHY of the Slave. If the Master receives both times at the same point in time, it can correlate the DAQ timestamp of the free-running clock with the grandmaster clock and its own time domain.
- > Another scenario arises when there is a free-running clock of the XCP Slave and an ECU clock and the DAQ timestamps originate from the ECU clock. This is the case when an external XCP Slave, such as the VX1000 measurement and calibration hardware is used from Vector, is used.
- > If all of the sketched solutions are combined, a total of three different clocks are involved: the free-running Slave clock, a clock which is synchronized with a grandmaster clock and the ECU clock.
- > In the last scenario, there is no Slave clock, but there is an ECU clock which is synchronized with a grandmaster clock.

Synchronization between the DAQ timestamps and the Master domain time can be realized for all scenarios in the Master using the XCP mechanisms.

1.4 XCP Transport Layers

A main requirement in designing the XCP protocol was that it must support different transport layers. At the time this document was defined, the following layers had been defined: XCP on CAN, FlexRay, Ethernet, SxI and USB. The bus systems CAN, LIN and FlexRay are explained on the Vector E-Learning platform, as well as an introduction to AUTOSAR. For details see the website www.vector-elearning.com.

1.4.1 CAN

XCP was developed as a successor protocol of the CAN Calibration Protocols (CCP) and must absolutely satisfy the requirements of the CAN bus. The communication over the CAN bus is defined by the associated description file. Usually the DBC format is used, but in some isolated cases the AUTOSAR format ARXML is being used too.

A CAN message is identified by a unique CAN identifier. The communication matrix is defined in the description file: Who sends which message and how are the eight useful bytes of the CAN bus being used? The following figure illustrates the process:

Data Frame	CAN Node A	CAN Node B	CAN Node C	CAN Node D
ID=0x12	Sender	Receiver		
ID=0x34		Sender	Receiver	Receiver
ID=0x52		Receiver		Sender
ID=0x67	Receiver	Receiver	Sender	Receiver
ID=0xB4	Receiver		Sender	
ID=0x3A5	Sender	Receiver	Receiver	Receiver

Figure 36:
Definition of which bus nodes send which messages

The message with ID 0x12 is sent by CAN node A and all other nodes on the bus receive this message. In the framework of acceptance testing, CAN nodes C and D conclude that they do not need the message and they reject it. CAN node B, on the other hand, determines that its higher-level layers need the message and they provide them via the Rx buffer. The CAN nodes are interlinked as follows:

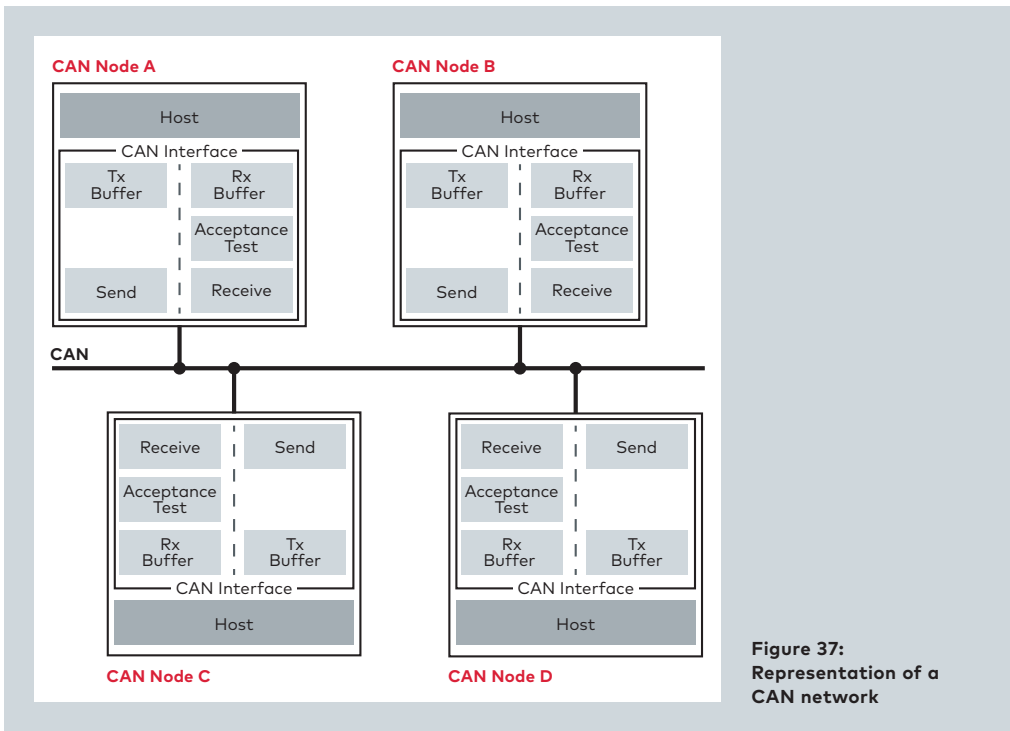

The XCP messages are not described in the communication matrix! If measured values are sent from the Slave via dynamic DAQ lists, e.g. with the help of XCP, the messages are assembled according to the signals selected by the user. If the signal selection changes, the message contents change as well. Nonetheless, there is a relationship between the communication matrix and XCP: CAN identifiers are needed to transmit the XCP messages over CAN. To minimize the number of CAN identifiers used, the XCP communication is limited to the use of just two CAN identifiers that are not being used in the DBC for "normal" communication. One identifier is needed to send information from the Master to the Slave; the other is used by the Slave for the response to the Master.

The excerpt from the CANape Trace window shows the CAN identifiers that are used under the "ID" column. In this example, just two different identifiers are used: 554 as the ID for the message from Master to Slave (direction Tx) and 555 for sending messages from the Slave to the Master (direction Rx).

Time	Id...	Name	Dir	DLC	Data	Interpretation
1557.862740	554	CMD	Tx	2	FF 00	CONNECT mode=0
1557.862788	555	RES	Rx	8	FF 1D C0 08 08 00 01 01	Ok:CONNECT resource=1Dh commMode=C0h ctoSize=8 dtoSize=8 pro...
1557.862819	554	CMD	Tx	1	FB	GET_COMM_MODE_INFO
1557.862833	555	RES	Rx	8	FF 1D 01 08 2B 00 00 19	Ok:GET_COMM_MODE_INFO commModeOptional=01h maxBs=43 minSt...
1557.862858	554	CMD	Tx	1	FD	GET_STATUS
1557.862868	555	RES	Rx	6	FF 00 1D 08 00 00	Ok:GET_STATUS sessionStatus=00h protectionStatus=1Dh configuratio...
1557.880057	554	CMD	Tx	3	F8 00 01	GET_SEED mode=0 res=01h
1557.880112	555	RES	Rx	8	FF 0A A7 88 5F D3 C3 58	Ok:GET_SEED length=10 data=A7h 88h 5Fh D3h C3h 58h
1557.880171	554	CMD	Tx	3	F8 01 01	GET_SEED mode=1 res=01h
1557.880184	555	RES	Rx	6	FF 04 1F 28 34 EF	Ok:GET_SEED length=4 data=1Fh 28h 34h EFh
1557.896871	554	CMD	Tx	8	F7 09 82 FC 3F 43 50 D2	UNLOCK length=09h key=82h FCh 3Fh 43h 50h D2h
1557.896936	555	RES	Rx	2	FF 1D	Ok:UNLOCK status=1Dh
1557.896972	554	CMD	Tx	5	F7 03 3B 00 86	UNLOCK length=03h key=3Bh 00h 86h
1557.897043	555	RES	Rx	2	FF 1C	Ok:UNLOCK status=1Ch
1557.907212	554	CMD	Tx	3	F8 00 04	GET_SEED mode=0 res=04h
1557.907238	555	RES	Rx	8	FF 0A 55 70 3F A8 DF 7D	Ok:GET_SEED length=10 data=55h 70h 3Fh A8h Dfh 7Dh
1557.907267	554	CMD	Tx	3	F8 01 04	GET_SEED mode=1 res=04h
1557.907273	555	RES	Rx	6	FF 04 A5 30 E9 E0	Ok:GET_SEED length=4 data=A5h 30h E9h E0h

Figure 38: Example of XCP-on-CAN communication

In this example, the entire XCP communication is handled by the two CAN identifiers 554 and 555. These two IDs may not be allocated for other purposes in this network.

The CAN bus transmits a maximum of eight useful bytes per message. In the case of XCP, however, we need information on the command used or the sent response. This is provided in the first byte of the CAN useful data. This means that seven bytes are available per CAN message for transporting useful data.

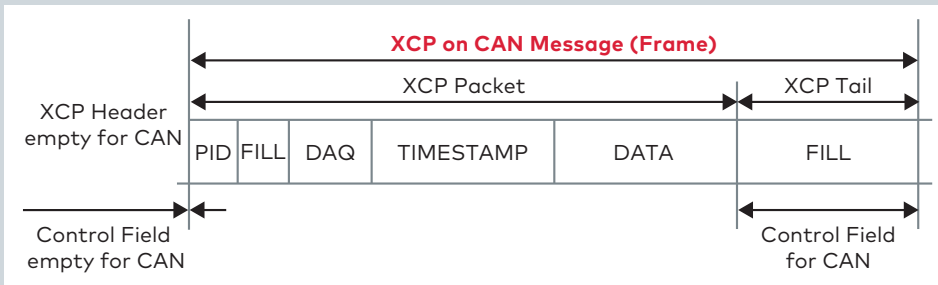

Figure 39: Representation of an XCP-on-CAN message

In CANape, you will find an XCP-on-CAN demo with the virtual ECU XCPsim. You can learn about more details of the standard in ASAM XCP on CAN Part 3 Transport Layer Specification.

1.4.2 CAN FD

CAN FD (CAN with flexible data rate) is an extension of the CAN protocol developed by Robert Bosch GmbH. Its primary difference to CAN involves extending the useful data from 8 to 64 bytes. CAN FD also offers the option of sending the useful data at a higher data rate. After the arbitration phase, the data bytes are sent at a higher transmission rate than during the arbitration phase. This covers the need for greater bandwidth in automotive networks while preserving valuable experience gained from CAN development.

The XCP-on-CAN-FD specification was defined in the XCP-on-CAN description of the XCP standard, Version 1.2 (June 2013).

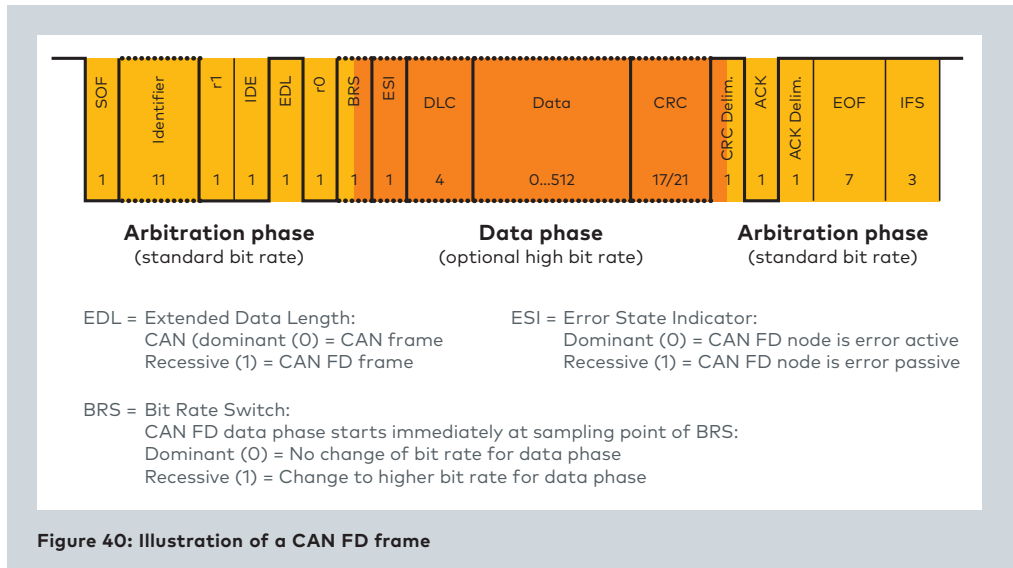

Despite the largely similar modes of operation, this protocol requires extensions and modifications to the hardware and software. Among other things, CAN FD introduces three new bits to the control field:

- > Extended Data Length (EDL)
- > Bit Rate Switch (BRS)
- > Error State Indicator (ESI)

A recessive EDL bit (high level) distinguishes frames in extended CAN-FD format from those in standard CAN format, because they are identified by a dominant EDL bit (low level). Similarly, a recessive BRS bit causes the transmission of the data field to be switched to the higher bit rate. The ESI bit identifies the error state of a CAN FD node. Another four bits make up what is known as the Data Length Code (DLC), which represents the extended useful data length as a possible value of 12, 16, 20, 24, 32, 48 and 64 bytes.

The use of XCP on CAN FD assumes that a second transmission rate has been defined for the useful data in the A2L file. This is fully transparent to the user, who gets a complete A2L parameterization. A measurement configuration in the XCP Master considers the maximum packet length, and the user does not need to make any other settings.

CAN FD is supported in CANape, Version 12.0 and higher. Every CAN hardware product from Vector which begins with "VN" supports the CAN FD transport protocol.

1.4.3 FlexRay

A basic idea in the development of FlexRay was to implement a redundant system with deterministic time behavior. The connection redundancy was achieved by using two channels: channel A and channel B. If multiple FlexRay nodes (= ECUs) are redundantly interconnected and one branch fails, the nodes can switch over to the other channel to make use of the connection redundancy.

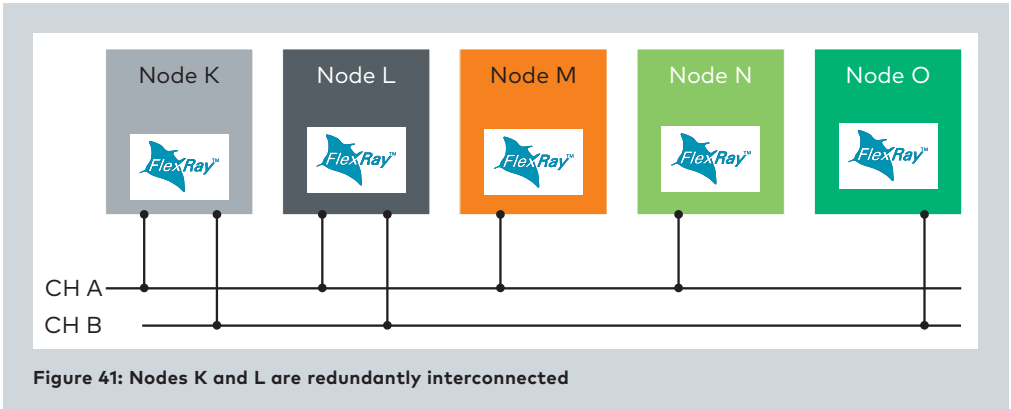

Figure 41: Nodes K and L are redundantly interconnected

Deterministic behavior is achieved by transmitting data within defined time slots. Also defined here is which node sends which content in which time slot. These time slots are combined to form one cycle. The cycles repeat here, as long as the bus is active. The assembly of the time slots and their transport contents (who sends what at which time) is known as scheduling.

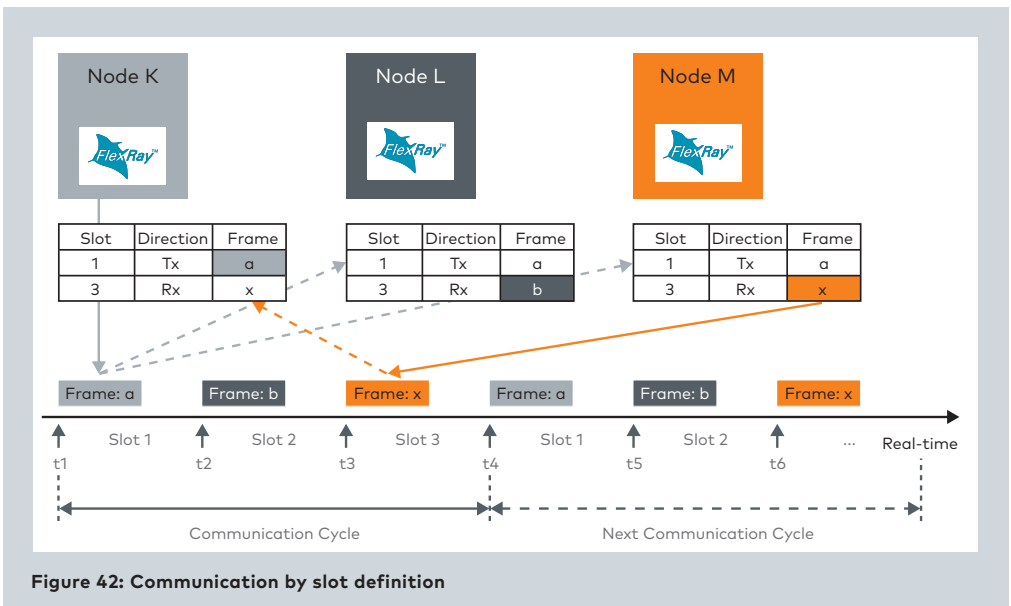

Figure 42: Communication by slot definition

In the first communication cycle, node K sends frame a in slot 1. The scheduling is also stored in the software of nodes L and M. Therefore, the contents of frame a are passed to the next higher communication levels.

Scheduling is consolidated in a description file. This is not a DBC file, as in the case of CAN, rather it is a FIBEX file. FIBEX stands for "Field Bus Exchange Format" and could also be used for other bus systems. However, its current use is practically restricted to the description of the FlexRay bus. FIBEX is an XML format and the XCP-on-FlexRay specification relates to FIBEX Version 1.1.5 and FlexRay specification Version 2.1.

	Slot	ECU	Channel	Cycles											
				0	1	2	3	4	5	6	...	63			
Static Segment	1	Node K	A	b [rep: 1]	b [rep: 1]	b [rep: 1]	b [rep: 1]	b [rep: 1]	b [rep: 1]	b [rep: 1]	b [rep: 1]	b [rep: 1]	b [rep: 1]	b [rep: 1]	
			B	b [rep: 1]	b [rep: 1]	b [rep: 1]	b [rep: 1]	b [rep: 1]	b [rep: 1]	b [rep: 1]	b [rep: 1]	b [rep: 1]	b [rep: 1]	b [rep: 1]	
	2	Node M	A	c [rep: 4]	x [rep: 2]	y [rep: 4]	x [rep: 2]	c [rep: 4]	x [rep: 2]	y [rep: 4]			x [rep: 2]		
			B												
	3	Node L	A	a [rep: 1]	a [rep: 1]	a [rep: 1]	a [rep: 1]	a [rep: 1]	a [rep: 1]	a [rep: 1]	a [rep: 1]	a [rep: 1]	a [rep: 1]	a [rep: 1]	
			B	d [rep: 1]	d [rep: 1]	d [rep: 1]	d [rep: 1]	d [rep: 1]	d [rep: 1]	d [rep: 1]	d [rep: 1]	d [rep: 1]	d [rep: 1]	d [rep: 1]	
Dynamic Segment	4	Node L	A	n [rep: 1]	n [rep: 1]	n [rep: 1]	n [rep: 1]	n [rep: 1]	n [rep: 1]	n [rep: 1]	n [rep: 1]	n [rep: 1]	n [rep: 1]		
			B	m [rep: 1]	m [rep: 1]	m [rep: 1]	m [rep: 1]	m [rep: 1]	m [rep: 1]	m [rep: 1]	m [rep: 1]	m [rep: 1]	m [rep: 1]		
	5	Node N	A	r [rep: 1]	r [rep: 1]	r [rep: 1]	r [rep: 1]	r [rep: 1]	r [rep: 1]	r [rep: 1]	r [rep: 1]	r [rep: 1]	r [rep: 1]		
			B												
	6	Node K	A												
			B	o [rep: 1]	o [rep: 1]	o [rep: 1]	o [rep: 1]	o [rep: 1]	o [rep: 1]	o [rep: 1]	o [rep: 1]	o [rep: 1]	o [rep: 1]		
	7	Node M	A		t [rep: 2]	p [rep: 4]	t [rep: 2]		t [rep: 2]	p [rep: 4]	t [rep: 2]	p [rep: 4]	t [rep: 2]		
			B												
	7	Node L	A	u [rep: 4]				u [rep: 4]							
			B			v [rep: 8]									
	Node O	A													
		B		w [rep: 4]				w [rep: 4]							

Figure 43: Representation of a FlexRay communication matrix

Another format for describing bus communication has been defined as a result of the development of AUTOSAR solutions: the AUTOSAR Description File, which is available in XML format. The definition of XCP-on-FlexRay was taken into account in the AUTOSAR 4.0 specification. However, at the time of publication of this book this specification has not yet been officially approved and therefore it will not be discussed further.

Due to other properties of the FlexRay bus, it is not sufficient to just give the slot number as a reference to the contents. One reason is that multiplexing is supported: whenever a cycle is repeated, the transmitted contents are not necessarily the same. Multiplexing might specify that a certain piece of information is only sent in the slot in every second pass.

Instead of indicating the pure slot number, "FlexRay Data Link Layer Protocol Data Unit Identifiers" (FLX_LPDU_ID) are used, which can be understood as a type of generalized Slot ID. Four pieces of information are needed to describe such an LPDU:

- > FlexRay Slot Identifier (FLX_SLOT_ID)
- > Cycle Counter Offset (OFFSET)
- > Cycle Counter Repetition (CYCLE_REPETITION)
- > FlexRay Channel (FLX_CHANNEL)

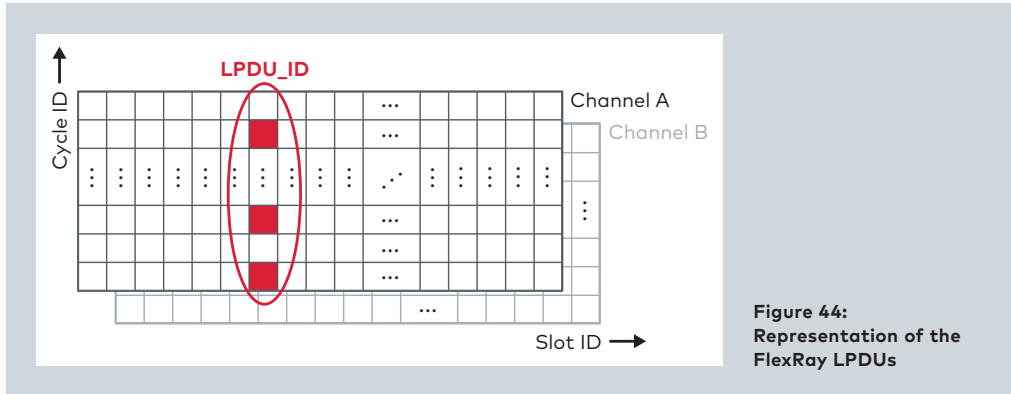

Figure 44:
Representation of the
FlexRay LPDUs

Scheduling also has effects on the use of XCP on FlexRay, because it defines what is sent precisely. This cannot be readily defined in XCP; not until the measurement runtime does the user define which measured values are sent by assembling signals. This means that it is only possible to choose which aspect of XCP communication can be used in which LPDU: CTO or DTO from Master to Slave or from Slave to Master.

The following example illustrates this process: the XCP Master may send a command (CMD) in slot n and Slave A gives the response (RES) in slot $n + 2$. XCP-on-FlexRay messages are always defined using LPDUs.

The A2L description file is needed for access to internal ECU parameters; the objects with their addresses in the ECU are defined in this file. In addition, the FIBEX file is necessary, so that the XCP Master knows which LPDUs it may send and to which LPDUs the XCP Slaves send their responses. Communication between XCP Master and XCP Slave(s) can only function through combination of the two files, i.e. by having an A2L file reference a FIBEX file.

Excerpt of an A2L with XCP-on-FlexRay parameter setting:

```
...
/begin XCP_ON_FLX
...
„XCPsim.xml“
„Cluster_1“
...
```

In this example, "XCPsim.xml" is the reference from the A2L file to the FIBEX file.

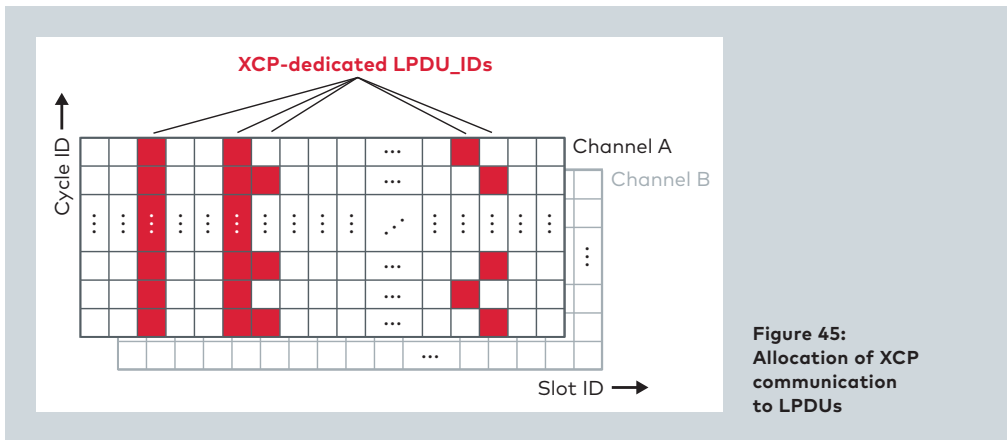

Figure 45:
Allocation of XCP
communication
to LPDUs

You can read more details about XCP on FlexRay in CANape's Online Help. Supplied with CANape is the FIBEX Viewer, which lets users conveniently view the scheduling. It is easy to allocate the XCP messages to the LPDUs by making driver settings for the XCP-on-FlexRay device in CANape.

The protocol is explained in detail in ASAM XCP on FlexRay Part 3 Transport Layer Specification. You will find an XCP-on-FlexRay demo in CANape with the virtual ECU XCPsim. The demo requires real Vector FlexRay hardware.

1.4.4 Ethernet

XCP on Ethernet can be used with either TCP/IP or UDP/IP. TCP is a protected transport protocol on Ethernet, in which the handshake method is used to detect any loss of a packet. In case of packet loss, TCP organizes a repetition of the packet. UDP does not offer this protection mechanism. If a packet is lost, UDP does not offer any mechanisms for repeated sending of the lost packet on the protocol level.

Not only can XCP on Ethernet be used with real ECUs, it can also be used for measurement and calibration of virtual ECUs. Here, a virtual ECU is understood as the use of code that would otherwise run in the ECU as an executable program (e.g. DLL) on the PC. Entirely different resources are available here compared to an ECU (CPU, memory, etc.).

But first the actual protocol will be discussed. IP packets always contain the addresses of the sender and receiver. The simplest way to visualize an IP packet is as a type of letter that contains the addresses of the recipient and the sender. The addresses of individual nodes must always be unique. A unique address comprises the IP address and port number.

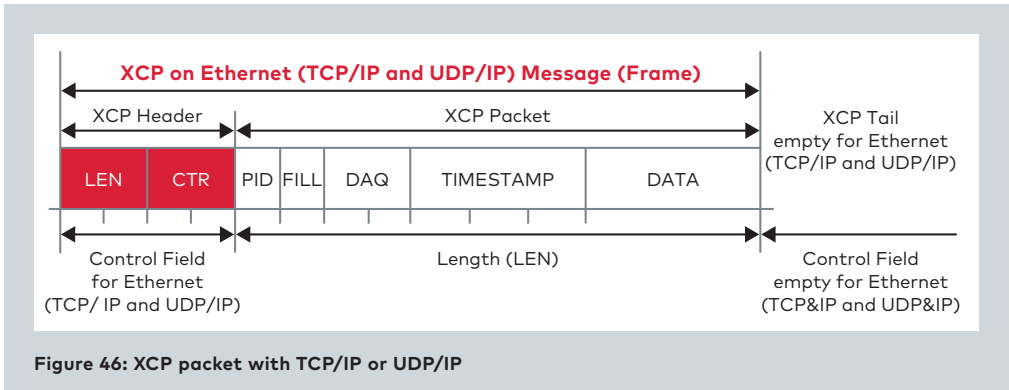

The header consists of a Control Field with two words in Intel format (= four bytes). These words contain the length (LEN) and a counter (CTR). LEN indicates the number of bytes in the XCP packet. The CTR is used to detect the packet loss. UDP/IP is not a protected protocol. If a packet is lost, this is not recognized by the protocol layer. Packet loss is monitored by counter information. When the Master sends its first message to the Slave, it generates a counter number that is incremented with each additional transmission of a frame. The Slave responds with the same pattern: It increments its own counter with each frame that it sends. The counters of the Slave and the Master operate independently of one another. UDP/IP is well suited for sending measured values. If a packet is lost, then the measured values it contains are lost, resulting in a measurement gap. If this occurs infrequently, the loss might just be ignored. But if the measured data is to be used as the basis for fast control, it might be advisable to use TCP/IP.

An Ethernet packet can transport multiple XCP packets, but an XCP packet may never exceed the limits of a UDP/IP packet. In the case of XCP on Ethernet, there is no "Tail", i.e. an empty control field.

Detection of XCP-on-Ethernet Slaves

With version 1.3 of the XCP standard, an expansion for XCP Slave detection was defined specifically for XCP on Ethernet.

The Master can detect the XCP Slaves using the GET_SLAVE_ID command. Here, the Master broadcasts a multicast message (IPv4) with the IP address 239.255.0.0 on port 5556. Regardless of whether or not an XCP Slave already has a connection to a Master, the Slave must process the request and return a response.

The response of the Slave contains, among other things:

- > The IP address (IPv4)
- > The port number
- > TCP, UDP or both
- > Information on the status of whether or not there is already a connection to an XCP Master

You will find more detailed information on the protocol in ASAM XCP on Ethernet Part 3 Transport Layer Specification. In CANape, you will also find an XCP on Ethernet demo with the virtual ECU XCPsim or with virtual ECUs in the form of DLLs, which have been implemented by Simulink models and the Simulink Coder.

1.4.5 SxI

SxI is a collective term for SPI or SCI. Since they are not buses, but instead are controller interfaces which are only suited for point-to-point connections, there is no addressing in this type of transmission. The communication between any two nodes runs either synchronously or asynchronously.

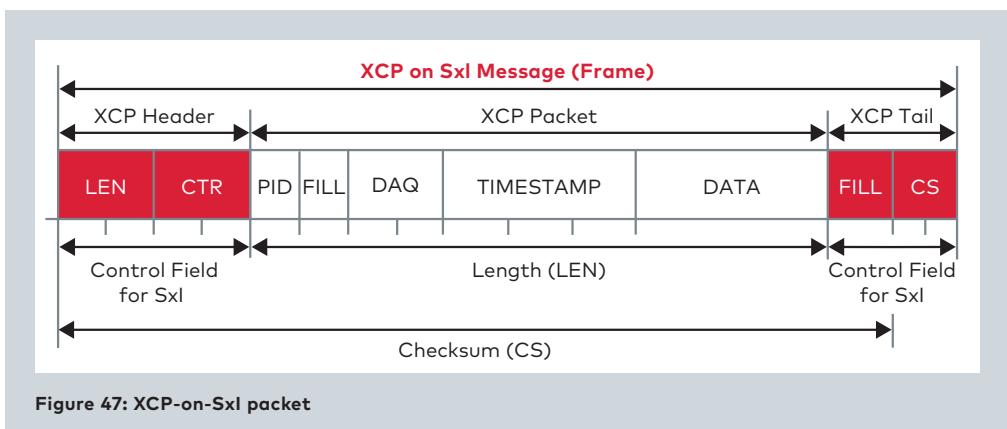

Figure 47: XCP-on-SxI packet

The XCP header consists of a control field with two pieces of information: the length LEN and the counter. The length of these parameters may be in bytes or words (Intel format). LEN indicates the number of bytes of the XCP packet. The CTR is used to detect the loss of a packet. This is monitored in the same way as for XCP on Ethernet: with counter informa-

tion. Under certain circumstances it may be necessary to add fill bytes to the packet, e.g. if SPI is used in WORD or DWORD mode or to avoid the message being shorter than the minimal packet length. These fill bytes are appended in the control field.

You will find more detailed information on the protocol in ASAM XCP on SxI Part 3 Transport Layer Specification.

1.4.6 USB

Currently, XCP on USB has no practical significance. Therefore, no further mention will be made of this topic; rather we refer you to ASAM documents that describe the standard: ASAM XCP on USB Part 3 Transport Layer Specification.

1.4.7 LIN

At this time, ASAM has not yet defined an XCP-on-LIN standard. However, a solution exists from Vector (XCP-on-LIN driver and CANape as XCP-on-LIN Master), which violates neither the LIN nor the XCP specification and is already being used on some customer projects. For more detailed information, please contact Vector.

1.5 XCP Services

This chapter contains a listing and explanation of other services that can be realized over XCP. They are all based on the already described mechanisms of communication with the help of CTOs and DTOs. Some XCP services have already been explained, e.g. synchronous data acquisition/stimulation and read/write access to device memory.

The XCP specification does indeed uniquely define the different services; at the same time it indicates whether the service always needs to be implemented or whether it is optional. For example, an XCP Slave must support "Connect" for the Master to set up a connection. On the other hand, flashing over XCP is not absolutely necessary and the XCP Slave does not need to support it. This simply depends on the requirements of the project and the software. All of the services described in this chapter are optional.

1.5.1 Memory Page Switching

As already explained in the description of calibration concepts, parameters are normally located in flash memory and are copied to RAM as necessary. Some calibration concepts offer the option of switching memory segment pages from RAM and Flash. XCP describes a somewhat more general, generic approach, in which a memory segment may contain multiple switchable pages. Normally, this consists of a RAM page and a flash page. But multiple RAM pages or the lack of a flash page are conceivable as well.

For a better understanding of the XCP commands for page switching, the concepts of sector, segment and page will be explained once again at this point.

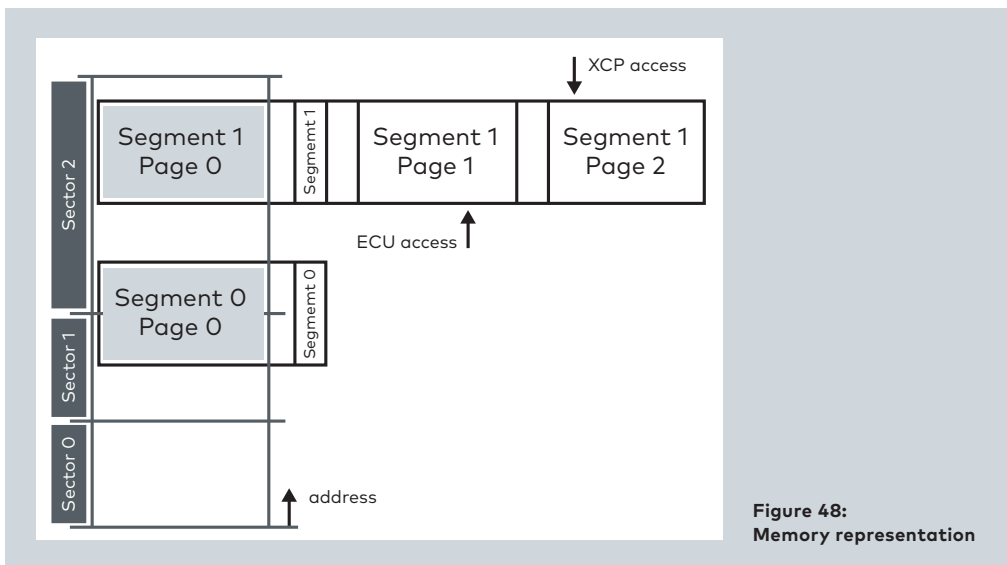

Figure 48:
Memory representation

From an XCP perspective, the memory of a Slave consists of a continuous memory that is addressed with a 40-bit width. The physical layout of the memory is based on sectors. Knowledge of the flash sectors is absolutely necessary in flashing, because the flash memory can only be erased a block at a time.

The logical structure is based on what are known as segments; they describe where calibration data is located in memory. The start address and parameters of a segment do not have to be aligned with the start addresses and parameters of the physical sectors. Each segment can be subdivided into multiple pages. The pages of a segment describe the same parameters at the same addresses. The values of these parameters and read/write rights can be controlled individually for each page.

The allocation of an algorithm to a page within a segment must always be unique. Only one page may be active in a segment at any given time. This page is known as the "active page for the ECU in this segment." The particular page that the ECU and the XCP driver actively access can be individually switched. No interdependency exists between these settings. Similar to the naming convention for the ECU, the active page for XCP access is referred to as the "active page for XCP access in this segment".

In turn, this applies to each individual segment. Segments must be listed in the A2L file and each segment gets a number that is used to reference the segment. Within an XCP Slave, the `SEGMENT_NUMBER` must always begin at 0 and it is then incremented in consecutive numbers. Each segment has at least one page. The pages are also referenced by numbers. The first page is `PAGE 0`. One byte is available for the number, so that a maximum of 255 pages can be defined per segment.

The Slave must initialize all pages for all segments. The Master uses the command `GET_CAL_PAGE` to ask the Slave which page is currently active for the ECU and which page for XCP access. It can certainly be the case that mutual blocking may be necessary for the accesses. For example, the XCP Slave may not access a page, if this page is currently active for the ECU. As mentioned, there may be a dependency – but not necessarily. It is a question of how the Slave has been implemented.

If the Slave supports the optional commands `GET_CAL_PAGE` and `SET_CAL_PAGE`, then it also supports what is known as page switching. These two commands let the Master poll which pages are currently being used and if necessary it can switch pages for the ECU and XCP access. The XCP Master has full control over switching of pages. The XCP Slave cannot initiate switching by itself. But naturally the Master must respect any restrictions of the Slave implementation.

What is the benefit of switching?

First, switching permits very quick changing of entire parameter sets – essentially a before-and-after comparison. Second, the plant remains in a stable state, while the calibrator performs extensive parameter changes on another page in the ECU. This prevents the plant from going into a critical or unstable state, e.g. due to incomplete datasets during parameter setting.

1.5.2 Saving Memory Pages – Data Page Freezing

When a calibrator calibrates parameters on a page, there is the conceptual ability in XCP to save the data directly in the ECU. This involves saving the data of a RAM page to a page in nonvolatile memory. If the nonvolatile memory is flash, it must be taken into account that the segment start address and the segment size might not necessarily agree with the flash sectors, which represents a problem in erasing and rewriting the flash memory (see ASAM XCP Part 2 Protocol Layer Specification).

1.5.3 Flash Programming

Flashing means writing data in an area of flash memory. This requires precise knowledge of how the memory is laid out. A flash memory is subdivided into multiple sectors (physical sections), which are described by a start address and a length. To distinguish them from one another, they each get a consecutive identification number. One byte is available for this number, resulting in a maximum of 255 sectors.

SECTOR_NUMBER [0, 1, 2 ... 255]

The information about the flash sectors is also part of the A2L data set.

Memory Flash

General | Expert settings

Start	End	Size	Concatenation
209000h	20A2DDh	12DEh	False

Insert... | Change... | Delete

Flash options

0x00 Optimization | CCP Flash kernel type

0xFF Optimization | Flash Kernel: Direct

Reconnect | Converter: Without

Flash signature

Enable flash signature

Address: E105C hex | Length: 18

Figure 49:
Representation
of driver settings
for the flash area

Flashing can be implemented using what are referred to as "flash kernels". A flash kernel is executable code that is sent to the Slave's RAM area before the actual flashing; the kernel then handles communication with the XCP Master. It might contain the algorithm that is responsible for erasing the flash memory. For security and space reasons, very frequently this code is not permanently stored in the ECU's flash memory. Under some circumstances, a converter might be used, e.g. if checksum or similar computations need to be performed.

Flashing with XCP roughly subdivides the overall flash process into three areas:

- > Preparation (e.g. for version control and therefore to check whether the new contents can even be flashed)
- > Execution (the new contents are sent to the ECU)
- > Post-processing (e.g. checksum checking etc.)

In the XCP standard, the primary focus is directed to the actual execution of flashing. Anyone who compares this operation to flashing over diagnostic protocols will discover that the process-specific elements, such as serial number handling with meta-data, are supported in a rather spartan fashion in XCP. Flashing in the development phase was clearly the main focus in its definition and not the complex process steps that are necessary in end-of-line flashing.

Therefore, what is important in the preparation phase is to determine whether the new contents are even relevant to the ECU. There are no special commands for version control. Rather the practice has been to support those commands specific to the project.

The following XCP commands are available:

PROGRAM_START: Beginning of the flash procedure

This command indicates the beginning of the flash process. If the ECU is in a state that does not permit flashing (e.g. vehicle speed > 0), the XCP Slave must acknowledge with an ERRor. The actual flash process may not begin until the PROGRAM_START has been successfully acknowledged by the Slave.

PROGRAM_CLEAR: Call the current flash memory erasing routine

Before flash memory can be overwritten with new contents, it must first be cleared. The call of the erasing routine via this command must be implemented in the ECU or be made available to the ECU with the help of the flash kernel.

PROGRAM_FORMAT: Select the data format for the flash data

The XCP Master uses this command to define the format (e.g. compressed or encrypted) in which the data are transmitted to the Slave. If the command is not sent, the default setting is non-compressed and non-encrypted transmission.

PROGRAM: Transfer the data to the XCP Slave

For the users who are very familiar with flashing via diagnostics: this command corresponds to TRANSFERDATA in diagnostics. Using this command, data is transmitted to the XCP Slave, which is then stored in flash memory.

PROGRAM_VERIFY: Request to check the new flash contents

The Master can request that the Slave perform an internal check to determine whether the new contents are OK.

PROGRAM_RESET: Reset request to the Slave

Request by the Master to the Slave to execute a Reset. Afterwards, the connection to the Slave is always terminated and a new CONNECT must be sent.

1.5.4 Automatic Detection of the Slave

The XCP protocol lets the Master poll the Slave about its protocol-specific properties. A number of commands are available for this.

GET_COMM_MODE_INFO

The response to this command gives the Master information about the various communication options of the Slave, e.g. whether it supports block transfer or interleaved mode or which minimum time intervals the Master must maintain between requests in these modes.

GET_STATUS

The response to this request returns all current status information of the Slave. Which resources (calibration, flashing, measurement, etc.) are supported? Are any types of memory activities (DAQ list configuration, etc.) still running currently? Are DTOs (DAQ, STIM) being exchanged right now?

GET_DAQ_PROCESSOR_INFO

The Master gets general information, which it needs to know about the Slave limitations: number of predefined DAQ lists, available DAQ lists and events, etc.

GET_DAQ_RESOLUTION_INFO

Other information about the DAQ capabilities of the Slave is exchanged via this command: maximum number of parameters for an ODT for DAQ and for STIM, granularity of the ODT entries, number of bytes in timestamp transmission, etc.

GET_DAQ_EVENT_INFO

When this command is used, the call is made once per ECU event. Information is transmitted here on whether the event can be used for DAQ, STIM or DAQ/STIM, whether the event occurs periodically and if so which cycle time it has, etc.

1.5.5 Block Transfer Mode for Upload, Download and Flashing

In the “normal” communication mode, each command from the Master is acknowledged by a response of the Slave. However, in some cases it may be desirable, for performance reasons, to use what is referred to as the block transfer mode.

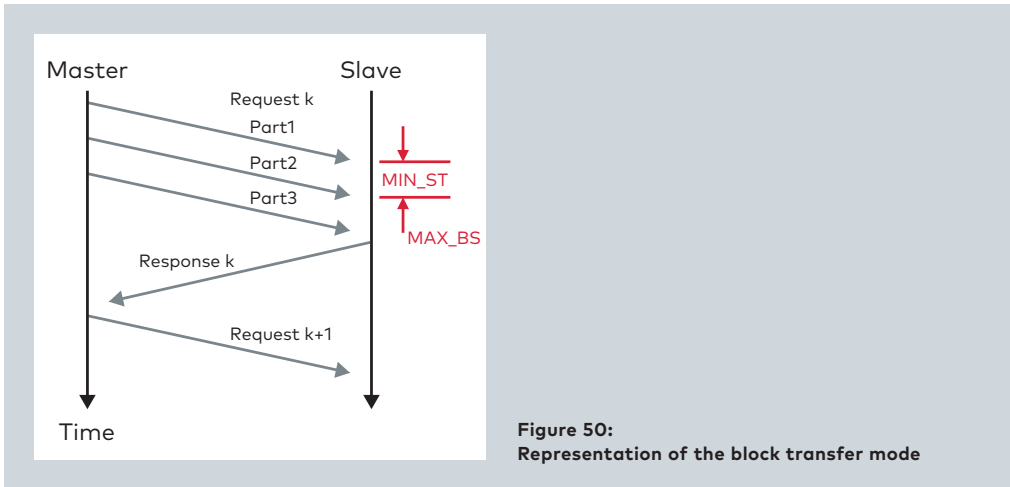

Figure 50:
Representation of the block transfer mode

The use of such a method accelerates the procedure when transmitting large amounts of data (UPLOAD, SHORT_UPLOAD, DOWNLOAD, SHORT_DOWNLOAD and PROGRAM). The Master can find out whether the Slave supports this method with the request GET_COMM_MODE_INFO. You will find more on this in ASAM XCP Part 2 Protocol Layer Specification.

1.5.6 Cold Start Measurement (during Power-On)

Even with the capabilities of XCP described to this point, it would be impossible to implement an event-driven measurement that can in practice be executed early in the ECU's start phase. The reason is that the measurement must be configured before the actual measurement takes place. If one attempts to do this, the ECU's start phase has long been over by the time the first measured values are transmitted. The approach that is used to overcome this problem is based on a simple idea.

It involves separating the configuration and the measurement in time. After the configuration phase, the measurement is not started immediately; rather the ECU is shut down. After a reboot, the XCP Slave accesses the existing configuration directly and immediately begins to send the first messages. The difficulties associated with this are obvious: the configuration of the DAQ lists is stored in RAM, and therefore the information no longer exists after a reboot.

To enable what is known as the RESUME mode to enable a Cold Start Measurement, a non-volatile memory is needed in the XCP Slave which preserves its data even when it is not being supplied with power. EEPROMs are used in this method. In this context, it is irrelevant whether it is a real EEPROM or one that is emulated by a flash memory.

You will find more details in ASAM XCP Part 1 Overview Specification in the chapter 1.4.2.2 "Advanced Features".

1.5.7 Security Mechanisms with XCP

An unauthorized user should be prevented as much as possible from being able to make a connection to an ECU. The "seed & key" method is available for checking whether or not a connection attempt is authorized. The three different access types can be protected by seed & key: measurement/stimulation, calibration and flashing.

The "seed & key" method operates as follows: in the connect request by the Master, the Slave sends a random number (= seed) to the Master. Now, the Master must use an algorithm to generate a response (= key). The key is sent to the Slave. The Slave also computes the expected response and compares the key of the Master with its own result. If the two results agree, both the Master and Slave have used the same algorithm. Then the Slave accepts the connection to the Master. If there is no agreement, the Slave declines communication with the Master.

Normally, the algorithm is available as a DLL in the Master. So, if a user has the "seed & key" DLL and the A2L file, nothing stands in the way of accessing the ECU's memory. When the ECU is approaching a production launch, the XCP driver is often deactivated. A unique sequence of individual diagnostic commands is usually used to restore XCP access to the ECU. This makes the XCP driver largely available even in production vehicles, but it is normally deactivated to protect against unauthorized manipulation of the ECU (see ASAM XCP Part 2 Protocol Layer Specification).

Whether or not seed & key or deactivation of the XCP driver is used in a project is implementation-specific and independent of the XCP specification.

2 ECU Description File A2L

One reason why an A2L file is needed has already been named: to allocate symbolic names to addresses. For example, if a software developer has implemented a PID controller and assigned the names P1, I1 and D1 in his application for the proportional, integral and differential components, then the calibrator should be able to access these parameters with their symbolic names. Let us take the following figure as an example:

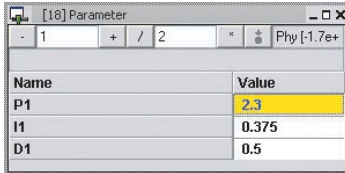

Name	Value
P1	2.3
I1	0.375
D1	0.5

Figure 51:
Parameters in a calibration window

The user can conveniently modify values using symbolic names. Another example is provided by viewing signal variables that are measured from the ECU:

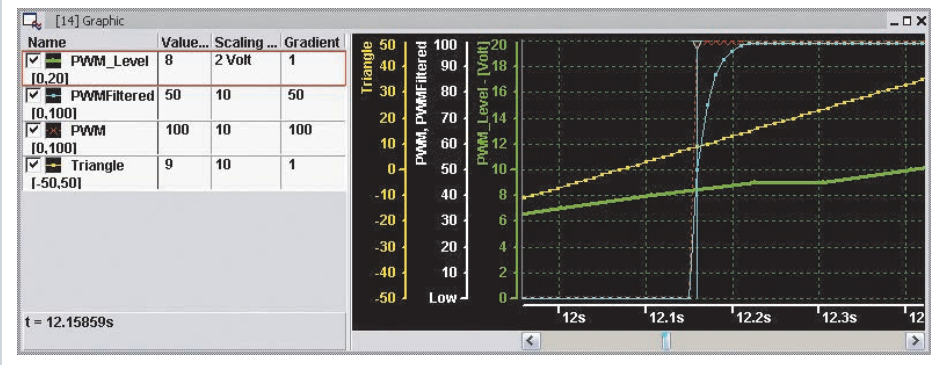

Figure 52: Signal response over time

In the legend, the user can read the logical names of the signals. The addresses at which the parameters were located in the ECU are of secondary importance in the offline analysis of values. Naturally, the correct address is needed to request the values in the ECU, but the numeric value of the address itself is of no importance to the user. The user uses the logical name for selection and visualization purposes. That is, the user selects the object by its name and the XCP Master looks for the associated address and data type in the A2L.

Another attribute of a parameter might be the definition of a minimum or maximum value. The value of the object would then have to lie within these limits. Imagine that you as the software developer define a parameter that has a direct effect on a power output stage. You must now prevent the user – whatever the user's reasons might be – from configuring the output stage that would result in catastrophic damage. You can accomplish this by defining minimum and maximum values in the A2L to limit the permitted values.

Rules for conversion between physical and raw values are also defined in the A2L. You can visualize a simple example of such a conversion rule in a sensor that has an 8-bit value. The numeric values output by the sensor lie between 0 and 255, but you wish to see the value as a percentage value. Mapping of the sensor value [0 ... 255] to [0 ... 100 %] is performed with a conversion rule, which in turn is stored in the A2L. If an object is measured, which exists as a raw value in the ECU and is also transmitted as such, the measurement and calibration tool uses the stored formula and visualizes the physical value.

Besides scalar parameters, characteristic curves and maps are frequently used. Some might utilize a proximity sensor such as a Hall sensor, which determines distance as a function of magnetic field strength and you may wish to use this distance value in your algorithm. The magnetic field and distance value do not run linear to one another. This nonlinearity of values would make formulation of the algorithm unnecessarily difficult. With the help of a characteristic curve, you can first linearize the values before you input the values into your algorithm as input variables.

Another application area for characteristic maps is their use as substitutes for complex computations. For example, if there is a relationship $y = f(x)$ and the function f is associated with a lot of computing effort, it is often simpler to simply compute the values over the potential range of x in advance and store the results in the form of a table (= characteristic curve). If the value x is now in the ECU, the value y does not need to be computed at the controller's runtime, rather the map returns the result y to the input variable x . It may be necessary to interpolate between two values, but that would be the extent of the calculations.

How is this characteristic curve stored in memory? Are all x values input first and then all y values? Or does storage follow the pattern: $x_1, y_1; x_2, y_2; x_3, y_3 \dots$? Since various options are available, the type of memory storage is defined in a storage scheme in the A2L.

The convenience for the user comes from the ability to work with symbolic names for parameters, the direct look at the physical values and access to complex elements such as characteristic maps, without having to concern oneself with complex storage schemes.

Another advantage is offered by the communication parameters. They are also defined in the A2L. In the communication between the measurement and calibration tool and the ECU, the parameter set from the A2L is used. The A2L contains everything that the measurement and calibration tool needs to communicate with the ECU.

2.1 Setting Up an A2L File for an XCP Slave

The A2L file is an ASCII-readable file, which describes the following with the help of keywords:

- > Interface-specific parameters between measurement and calibration tool and A2L file (the description is located at the beginning of the A2L file and is located in what is referred to as the AML tree),
- > Communication to the ECU,
- > Storage scheme for characteristic curves and maps (keyword RECORD_LAYOUT),
- > Conversion rules for converting raw values to physical values (keyword COMPU_METHOD),
- > Measurement parameters (keyword MEASUREMENT),
- > Calibration parameters (keyword CHARACTERISTIC) and
- > Events that are relevant for triggering a measurement keyword EVENT),

A summary of parameters and measurement parameters is made with the help of groups (keyword GROUP).

Example of a measurement parameter with the name "Shifter_B3":

```

/begin MEASUREMENT Shifter_B3 „Single bit signal (bit from a byte shifting)“
  UBYTE HighLow 0 0 0 1
  READ_WRITE
  BIT_MASK 0x8
  BYTE_ORDER MSB_LAST
  ECU_ADDRESS 0x124C02
  ECU_ADDRESS_EXTENSION 0x0
  FORMAT „%.3“
/begin IF_DATA CANAPE_EXT
  100
  LINK_MAP „byteShift“ 0x124C02 0x0 0 0x0 1 0x87 0x0
  DISPLAY 0 0 20
/end IF_DATA
/end MEASUREMENT

```

Example of a parameter map with the name KF1:

```

/begin CHARACTERISTIC KF1 „8*8 BYTE no axis“
  MAP 0xE0338 __UBYTE_Z 0 Factor100 0 2.55
  ECU_ADDRESS_EXTENSION 0x0
  EXTENDED_LIMITS 0 2.55
  BYTE_ORDER MSB_LAST
  BIT_MASK 0xFF
/begin AXIS_DESCR
  FIX_AXIS NO_INPUT_QUANTITY BitSlice.CONVERSION 8 0 7
  EXTENDED_LIMITS 0 7

```

```

    READ_ONLY
    BYTE_ORDER MSB_LAST
    FORMAT „%.0“
    FIX_AXIS_PAR_DIST 0 1 8
/end AXIS_DESCR
/begin AXIS_DESCR
    FIX_AXIS NO_INPUT_QUANTITY BitSlice.CONVERSION 8 0 7
    EXTENDED_LIMITS 0 7
    READ_ONLY
    BYTE_ORDER MSB_LAST
    FORMAT „%.0“
    FIX_AXIS_PAR_DIST 0 1 8
/end AXIS_DESCR
/begin IF_DATA CANAPE_EXT
    100
    LINK_MAP „map3_8_8_uc“ 0xE0338 0x0 0 0x0 1 0x87 0x0
    DISPLAY 0 0 255
/end IF_DATA
    FORMAT „%.3“
/end CHARACTERISTIC

```

The ASCII text is not easy to understand. You will find a description of its structure in ASAM XCP Part 2 Protocol Layer Specification in chapter 2.

The sections below describe how to create an A2L. Let us focus on the actual contents of an A2L and their meanings and leave the details of the A2L description language to an editor. The A2L Editor that is supplied with CANape is used here.

2.2 Manually Creating an A2L File

The A2L mainly describes the contents of the memory of the XCP Slave. The contents depend on the application in the Slave, which was developed as C code. After the compiler/linker run of the application code, important elements of an A2L file already exist in the linker-map file: the names of the objects, their data types and memory addresses. Still lacking are the parameters for communication between XCP Master and Slave. Other information is usually needed such as minimum and maximum values of parameters, conversion rules, storage schemes for characteristic maps etc.

Let us begin by creating an empty A2L and the communication parameters: If you wish to create an A2L that describes an ECU with an XCP-on-CAN interface, for example, you create a new device in CANape and select XCP on CAN as the interface. Then you can supplement this with other communication-specific information (e.g. CAN identifiers). After saving the file, you have an A2L that contains the entire communication content of the A2L. Still lacking are the definitions of the actual measurement and calibration parameters.

In the A2L Editor, the linker-map file is associated to the A2L. In a selection dialog, the user can now select those parameters from the map file which it needs in the A2L: scalar measurement and calibration parameters, characteristic curves and maps. The user can gradually add the desired parameters to the A2L step by step and group them. Other object-specific information is also added using the editor.

What should be done when you modify your code, recompile it and link it? It is highly probable that the addresses of objects will change. Essentially, it is not necessary to generate a new A2L. If you wish to have objects just added to the code also be available in the A2L, you must of course add them to the A2L. Address updating is always necessary in the A2L. This is done with the editor; it searches for the relevant entry in the linker-map file based on the name of the A2L object, reads out the address and updates it in the A2L.

If your application changes very dynamically – objects are renamed, data types are adapted, parameters are deleted and others added – then the manual work method is impractical. To generate an A2L from a C code, other tools are available for automatic processing.

On the Vector homepage you will find information on the "ASAP2 Tool-Set" with which you can automate the generation of A2Ls from the source code in a batch process.

2.3 A2L Contents versus ECU Implementation

When an XCP Master tool reads in an A2L that does not fully match the ECU, misunderstandings in the communication might occur. For example, another value related to timestamp resolution might be in the A2L file that differs from the value implemented in the ECU. If this is the case, the problem must be detected and solved. The user gets support from the Master, who can poll the Slave via the protocol to determine what was really implemented in the Slave.

XCP offers a number of functions that were developed for automatic detection of the Slave. Of course, this assumes that automatic detection is implemented in the Slave. If the Master polls the Slave and the Slave's responses do not agree with the parameter set of the A2L description file, the Master must decide which settings to use. In CANape, the information that is read out by the Slave is given a higher priority than the information from the A2L.

Here is an overview of possible commands that are used to find out something about the XCP implementation in the Slave:

GET_DAQ_PROCESSOR_INFO

Returns general information on the DAQ lists: MAX_DAQ, MAX_EVENT_CHANNEL, MIN_DAQ

GET_DAQ_RESOLUTION_INFO

Maximum parameter of an ODT entry for DAQ/STIM, time interval information

GET_DAQ_EVENT_INFO (Event_channel_number)

Returns information for a specific time interval: Name and resolution of the time interval, number of DAQ lists that may be assigned to this time interval ...

GET_DAQ_LIST_INFO (DAQ_List_Number)

Returns information on the selected DAQ list: MAX_ODT, MAX_ODT_ENTRIES exist as pre-defined DAQ lists ...

3 Calibration Concepts

ECU parameters are constant parameters that are adapted and optimized during the development of the ECU or an ECU variant. This is an iterative process, in which the optimal value of a parameter is found by repeated measurements and changes.

The calibration concept answers the question of how parameters in the ECU can be changed during an ECU's development and calibration phases. There is not one calibration concept that exists, rather several. Which concept is utilized usually depends very much on the capabilities and resources of the microcontroller that is used.

Normally, parameters are stored in the production ECU's flash memory. The underlying program variables are defined as constants in the software. To make parameters modifiable at runtime during an ECU's development, additional RAM memory is needed.

A calibration concept is concerned with such questions as these: How do the parameters initially find their way from flash to RAM? How is the microcontroller's access to RAM rerouted? What does the solution look like when there are more parameters than can be simultaneously stored in RAM? How are the parameters copied back into flash? Are changes to the parameters persistent, i.e. are they preserved when the ECU is turned off?

A distinction is made between transparent and non-transparent calibration concepts. Transparent means that the calibration tool does not need to be concerned with the above questions, because all necessary mechanisms are implemented in the ECU.

Several methods are briefly introduced in the following.

3.1 Parameters in Flash

The software developer defines in the source code whether a parameter is a variable or a constant, i.e. whether a parameter is stored in flash or in RAM memory.

C code example:

```
const float factor = 0.5;
```

The "factor" parameter represents a constant with the value 0.5. During compiling and linking of the code, memory space is provided in flash for the "factor" object. The object is allocated an address that lies in the data area of the flash memory. The value 0.5 is found at the relevant address in the hex file and the address appears in the linker-map file.

The simplest conceivable calibration concept involves modifying the value in C code, generating a new hex file and flashing. However, this method is very laborious, because every value change must be made in code, resulting in the need for a compiler/linker run with subsequent flashing. An alternative approach would be to only modify the value in the hex file and then reflash this file. Every calibration tool is capable of doing this. It is referred to as "offline calibration" of the hex file, which is a very commonly used method.

Under some circumstances, with certain compilers it may be necessary to explicitly ensure that parameters are always also stored in flash memory and not integrated in the code, for example and therefore do not appear at all in the linker-map file. Usually, one does not want to leave to chance where a constant is created in flash memory. The necessary means for accomplishing this are almost always compiler-specific pragma instructions. To prevent the compiler from embedding them in the code, it is generally sufficient to use the "volatile" attribute for constant parameters. A typical definition of a flash constant appears as in the following example:

C code example:

```
#pragma section "FLASH_Parameter"  
volatile const float factor = 0.5;
```

It is normally not possible to calibrate parameters in flash online. Indeed, most microcontrollers are able to program their flash themselves, which is necessary for the purposes of re-programming in the field. Nonetheless, flash memory always has the property of being organized into larger blocks (sectors), which can only be erased as a whole. It is practically impossible to flash just individual parameters, because the ECU normally does not have the resources to buffer the rest of the sector and reprogram it. In addition, this process would take too much time.

Some ECUs have the ability to store data in what is known as an EEPROM memory. In contrast to flash memories, EEPROM memories can erase and program each memory cell individually. The amount of available EEPROM memory is always considerably less than the available flash memory and it is usually limited to just a few kilobytes. EEPROM memory is often used to store programmable parameters in the service shop or to implement a persistence mechanism in the ECU, e.g. for the odometer. Online calibration would be conceivable here, but it is seldom used, because access to EEPROM cells is relatively slow and during the booting process EEPROM parameters are usually copied over to RAM memory, where it is possible to access them directly. ECUs which have no EEPROM memory often implement what is known as an EEPROM emulation. In this method, multiple small flash sectors are used in alternation to record parameter changes, so that the last valid value can always be determined. Online calibration would also be conceivable with this method.

In both cases, the relevant memory accesses would then be intercepted in the software components of the XCP driver and implemented with the software routines of the EEPROM or the EEPROM emulation. The Vector XCP Professional driver offers the software hooks needed for this.

3.2 Parameters in RAM

The most frequently used approach to modifying parameters at runtime ("online calibration") is to create the parameters in the available RAM memory.

C code example:

```
#pragma section "RAM_Parameter"
volatile float factor = 0.5;
```

This defines the parameter "factor" as a RAM variable with the initial value 0.5. During compiling and linking of the code, memory space is reserved for the object "factor" in RAM and the associated RAM address appears in the linker-map file. The initial value 0.5 is stored in flash memory and at the relevant location in the hex file. The addresses of the initial values in flash memory are defined by parameterization of the linker, but they do not appear in the linker-map file.

During booting of the ECU, all RAM variables are initialized once with their initial values from flash memory. This is usually executed in the start-up code of the compiler producer and the application programmer does not need to be concerned with it. The application uses the values of parameters located in RAM and they can be modified via normal XCP memory accesses.

From the perspective of the ECU software, calibration parameters in RAM are always still unchangeable, i.e. the application itself does not change them. Many compilers discover this fact by code analysis and simply optimize the necessary RAM memory space away. Normally, it is therefore also necessary to prevent the compiler from optimizing by using the "volatile" attribute.

From the perspective of the calibration tool, the RAM area in which the parameters are located is referred to as calibration RAM (memory that can be calibrated).

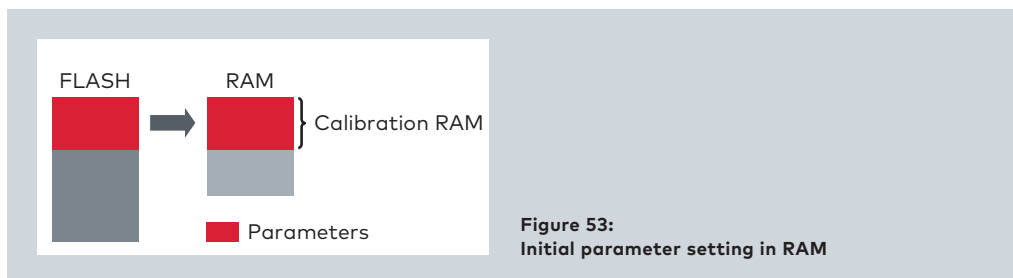

Figure 53:
Initial parameter setting in RAM

The calibration RAM does not need to consist of a fully contiguous RAM area. It may also be distributed into multiple areas or even in any desired way. Nonetheless, it offers significant advantages for organizing the parameters in just a few contiguous RAM areas and isolating them from other RAM parameters such as changing state variables and intermediate results. This is especially important if offline calibration of the calibration RAM with a hex file should be enabled. At the user's request, the calibration tool must be able to load the

parameters that were modified offline into the ECU during the transition from offline calibration to online calibration.

This case occurs very frequently. For example, when calibrators reconnect with their ECU on the next work day, they want to resume work at the point at which they stopped the evening before. However, booting of the ECU causes the flashed contents to be copied to the RAM as an initial dataset. To let users resume with work accomplished on the previous day, the parameter set file saved the previous evening in the ECU's RAM must be loaded. This loading process may be time optimized by limiting the number of necessary transmissions to a minimum. It is advantageous here if the tool can quickly and reliably determine – by forming a checksum over larger contiguous areas – whether there are differences. If there are no differences between the calibration RAM contents in the ECU and the file modified using the tool, this area does not need to be transferred. If the memory area with the calibration parameters is not clearly defined, or if it includes parameters that are modified by the ECU software, a checksum calculation always shows a difference and the parameter values are transmitted, either from the ECU to the XCP Master or in a reverse direction. Depending on the transmission speed and amount of data, this transmission could take several minutes.

Another advantage of clearly defined memory segments is that the memory area for initial values in flash memory can be used for offline calibration. The contents of the flash memory are defined using flashable hex files. If the calibration tool knows the location of parameters in the hex file, it can modify their values and implement new initial values in the ECU by flashing the modified hex file.

The calibration tool not only needs to know the location of parameters in RAM, but also the initial values in flash. A prerequisite is that the RAM memory segment must be initialized by copying from an identically laid out memory segment in flash, as is the usual practice in most compilers/linkers. If the addresses of parameters in RAM are in the A2L file, it is only necessary to let the tool know the offset to the start address of the calibration RAM, which it must add to get to the start address of the relevant flash area. This offset then applies to each individual parameter in the A2L.

The calibration tool can then either generate flashable hex files for this area itself, or it can place them directly on the original hex files of the linker to modify the initial values of parameters in the hex file.

3.3 Flash Overlay

Many microcontrollers offer options for overlaying memory areas in flash with internal or external RAM. This process is referred to as flash emulation or flash overlay. A lot is possible, from the use of a Memory Management Unit all the way to dedicated mechanisms that precisely serve this purpose. In this case the parameters are created as parameters in flash just as in calibration concept 1. This method offers enormous advantages compared to the described calibration concept 2 "Parameters in RAM":

- > No distinction is made between flash and RAM addresses. The flash addresses are always located in the A2L file, the hex file and linker-map file. This produces clear relationships, the hex file is directly flashable and the A2L file matches it exactly.
- > The overlay can be activated or deactivated as a whole, which enables lightning-quick swapping between values in flash and those in RAM. They are referred to as the RAM page and the flash page of a memory segment. XCP supports control of memory page switching with special commands.
- > The memory pages might be switched separately, e.g. for XCP access and ECU access, i.e. XCP could access a memory page while the ECU software works with the other page. This permits such operations as downloading of the offline calibration data to RAM, while the ECU is still working with the flash data; this avoids potential inconsistencies that could be problematic on a running ECU.
- > The overlay with RAM does not need to be complete and it can be adapted to the application case. It is possible to work with less RAM than with flash. More on this later.

A typical procedure for connecting the calibration tool to the ECU with the subsequent download of values that were calibrated offline appears as follows:

Connects to the ECU	CONNECT
Connects XCP Master to RAM page	SET_CAL_PAGE XCP to RAM
Checksum calculation	CALC_CHECKSUM

When a difference has been detected in the checksum calculation over the RAM area, first the user is normally asked how to proceed. Should the contents of ECU RAM be sent to the Master, or should the contents of a file on the Master page be sent to the ECU's RAM? If the user decides to write the offline changes to the ECU, the subsequent process appears as follows:

ECU should use the dataset of the flash page	SET_CAL_PAGE ECU to FLASH
Copy file from Master to the RAM page	DOWNLOAD ...
ECU should use the dataset of the RAM page	SET_CAL_PAGE ECU to RAM

Afterwards, the memory page is always switched over to RAM, so that parameters can be modified. But the user can also explicitly indicate which memory page should be active in the ECU. For example, the behavior of the RAM parameter set can be compared to that of the flash parameter set, or in an emergency it can be switched back to a proven parameter set in flash at lightning speed.

3.4 Dynamic Flash Overlay Allocation

The concepts for calibration RAM described so far are unproblematic if sufficient RAM is available for all parameters. But what if the total number of parameters does not fit into the available RAM area?

Here, it is advisable to overlay flash with RAM dynamically and do not overlay the affected flash memory with RAM until the actual write access to a parameter. This procedure can occur with a certain granularity and – depending on the implementation – it may be transparent to the calibration tool from the XCP perspective. If the XCP driver detects a write access to flash in the ECU which would lead to a change, a part of calibration RAM is used to copy over the relevant part of flash and activate the overlay mechanism for this part. This involves allocating the RAM, i.e. in a fixed layout and it is identified as utilized. However, the resources of the calibration RAM are limited. During the calibration process, RAM area that has already been allocated is no longer released, so the available calibration RAM dwindles with further requests. If the RAM resources are used up and a new allocation is required, the user is informed of the exhausted RAM resources. The user is offered the option of flashing or saving the changes made up to that point. This frees up the allocated RAM area again and the user can once again calibrate. The variant in which the ECU autonomously flashes the previously changed parameters is usually ruled out here for the reasons already cited in calibration concept “Parameter in Flash”.

In some cases, the download of a parameter set created offline might not be executable due to insufficient RAM resources. The only alternative is to flash it. The user can always cancel the changes from the tool and this releases the allocated RAM blocks again.

In this concept, page switching between the RAM and flash pages is also possible without any limitations. The parameters should be organized together in flash according to function, so that the available RAM blocks can be used as efficiently as possible. The software developer then specifies that the parameters, which belong together thematically, also lie in a contiguous memory area. After copying to RAM, the parameters needed for tuning the particular function are fully ready for use.

3.5 RAM Pointer Based Calibration Concept per AUTOSAR

This concept does not require necessarily the use of an AUTOSAR operating system; it can even be used in a different environment – e.g. without an operating system. The concept exhibits a key similarity to the previous concept. The primary difference is that the substitution of flash for RAM is not implemented by hardware mechanisms, but by software mechanisms instead. The calibration parameters are always referenced by pointers from the ECU software. Flash or RAM contents are accessed by changing this pointer. The flash parameters to be modified are copied to a defined block with available RAM. This method can be implemented fully transparently from the XCP perspective, just as in the previous method. As an alternative, the user of the calibration tool can explicitly select the parameters to be modified by preselecting the desired parameters. The advantage of this is that resource utilization and loading is visible to the user and the user is not surprised by a lack of memory in the midst of working.

3.5.1 Single Pointer Concept

The pointer table is located in RAM. When booting the ECU, all pointers indicate the parameter values in flash. The location and parameters of the calibration RAM are indeed known, but it does not yet contain any parameter values after booting. Initially, the application works entirely from flash.

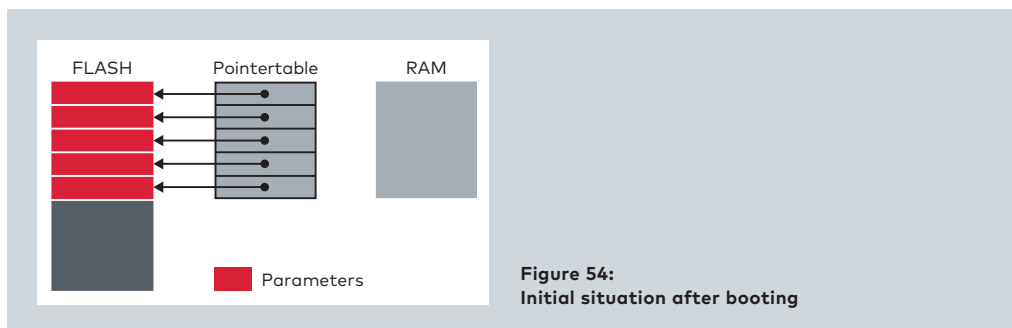

When the user selects a parameter from the A2L file for the first time after booting and wishes to write access it, this triggers a copying operation within the ECU first. The XCP Slave determines that the address to which the access should be made is located in the flash area, and it copies the parameter value to the calibration RAM. A change is also made in the pointer table to ensure that the application no longer gets the parameter value from flash, but instead from the RAM area:

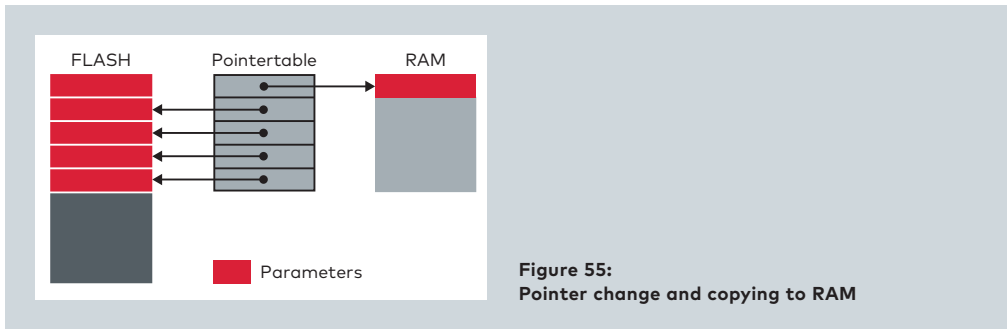

The application continues to get the parameter value via the pointer table. But since the pointer indicates the RAM address, the value is retrieved from there. As a result, the user can change the parameter value via XCP and observe the effects of the change in the measurement. The disadvantage of this method is that an entry in a pointer table must be available for each parameter and in turn the method is associated with substantial additional RAM memory requirements for the pointer table.

The next figure illustrates the problem. Three parameters of a PID controller (P, I and D) are contained in an ECU's flash area. The RAM addresses and parameter values in RAM are also already changed in the pointer table.

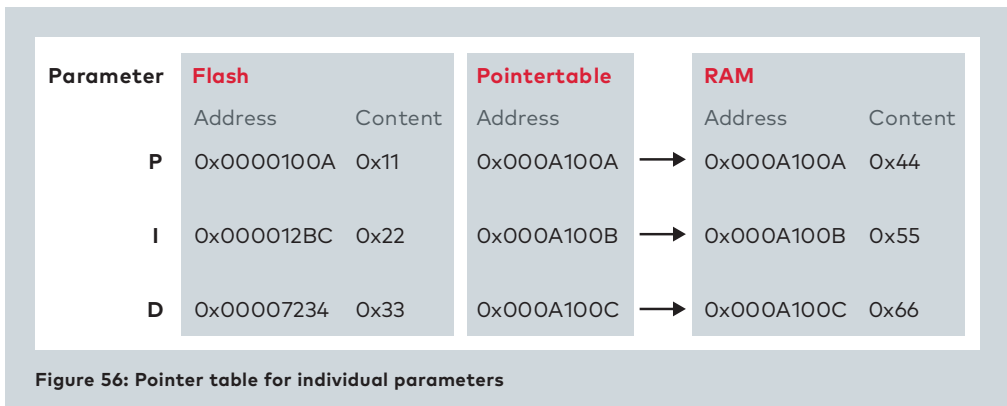

Calibration concepts are very important, because RAM resources are scarce. Large RAM pointer tables would make a concept self-defeating.

To avoid having to create a pointer for each individual parameter and having the method be used as such, the parameters can be combined into structures. This requires just one pointer per structure. When the user selects a parameter, not only is this parameter copied to RAM, but so is the entire associated structure. The granularity of the structures is of key importance here. With large structures only a few pointers are necessary. In turn, this means that with the decision for a specific parameter, a rather large associated structure is copied to the RAM area and this can cause the limits of calibration RAM space to be reached quickly.

Example:

The calibration RAM should be 400 bytes in size. Four structures are defined in the software with the following parameters:

Structure A: 250 bytes
Structure B: 180 bytes
Structure C: 120 bytes
Structure D: 100 bytes

When the user selects a parameter from structure A, the 250 bytes are copied from flash to the calibration RAM, and the user has XCP access to all parameters located in structure A. If the calibration task is limited to the parameters of this structure, the calibration RAM is fully sufficient. However, if the user selects another parameter located in a different structure, e.g. structure C, these 120 bytes must also be copied to the calibration RAM. Since the calibration RAM can handle 400 bytes, the user can access all parameters of structures A and C simultaneously.

If another selected parameter is not located in structure C, but rather in structure B, the 180 bytes of structure B would have to be copied to RAM in addition to the 250 bytes of structure A. However, since the space in RAM is inadequate for this, the user indeed has access to the parameters of structure A, but not to the data of structure B, because the ECU cannot execute the copy command.

You can learn more about how this approach works in CANape. Start CANape with the "AUTOSAR Single Pointered Demo" project. You will find more information on its use in CANape on the "Introduction" page of the project.

You will find a source code example under the "Demos" category at the Vector Download Center. A code example on how to use the calibration concept is contained in the "XCP Sample Implementation" under `<Installation DIR>\Samples\CAN\CAN MPC55xx\XCPDemo`.

3.5.2 Double Pointer Concept

A disadvantage of the single pointer concept is that memory page switching is not easy to implement. The calibration tool could simply describe the pointer table completely for page swapping, but this is not feasible in a short period of time without resulting in temporary inconsistencies and side effects. A tool-transparent implementation would double the memory space requirement for the pointer table, because when switching the memory page into flash, a copy of the previous pointer table would have to be created with RAM pointers.

For applications with large pointer tables, a transparent implementation or a fully consistent switching, there is the option of extending the method to a double pointer concept. To explain how this is done, we return once again to the initial RAM setting.

Figure 57 represents the pointer table. It lies in RAM. As already mentioned, this table must be copied from flash into RAM. As a result, this table lies in flash memory. If another pointer is now used (a table pointer), which points to either the pointer table in RAM or in flash, one arrives at a double pointer solution.

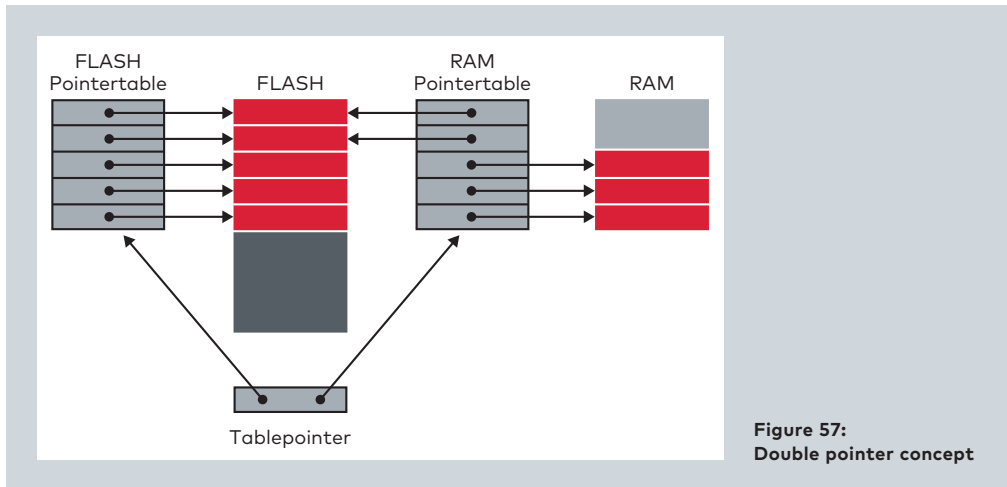

Figure 57:
Double pointer concept

The parameter values are initially accessed via the table pointer. If the table pointer indicates the pointer table in RAM, the application essentially accesses the actual parameters via the contents of the RAM pointer table. The low access speed and the creation of more program code are disadvantages of this solution.

3.6 Flash Pointer Based Calibration Concept

This method was patented several years ago by the company ZF Friedrichshafen under the name "InCircuit2" and bears a strong resemblance to the pointer-based concept of AUTOSAR. Here too, the application in the ECU accesses parameter data using a pointer table. However, this pointer table is not located in RAM, but in flash instead. Changes to the pointer table can therefore only be made by flash programming. A tool-transparent implementation is not possible. The advantage lies in the RAM memory that is saved since it no longer contains the pointer table.

You can find out how this approach works in CANape. Start CANape with the "InCircuit2" project. You will find more information on its use in CANape on the "Introduction" page of the project.

4 Application Areas of XCP

When ECU calibrators think about the use of XCP, they are usually fixated on use of the protocol in the ECU.

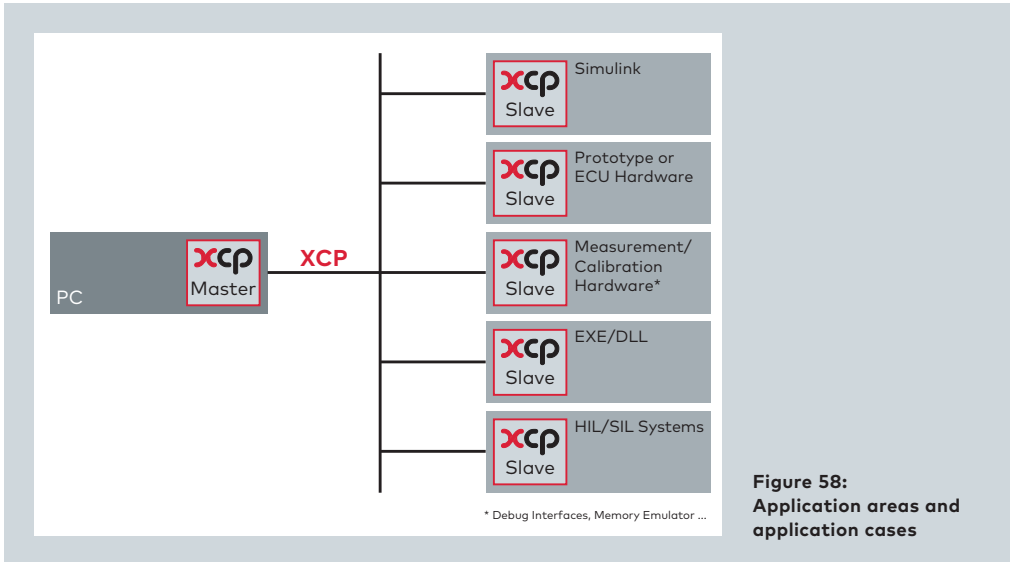

Figure 58:
Application areas and application cases

In a survey of development processes, one encounters many different solution approaches for the development of electronics and software. HIL (Hardware in the Loop), SIL (Software in the Loop) and Rapid Prototyping are keywords here and they describe different scenarios. They always have a "plant" and a "controller" in common.

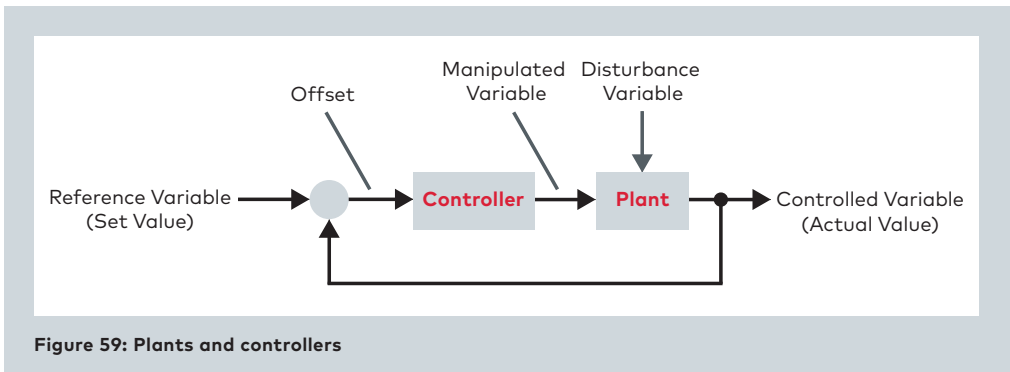

Figure 59: Plants and controllers

In the context of automotive development, the controller is represented by the ECU and the plant is the physical system to be controlled such as the transmission, engine, side mirrors, etc.

The rough subdivision is made between different development approaches according to whether the controller or the plant runs in real or simulated mode. Some combinations will be described in greater detail.

4.1 Model in the Loop (MIL)

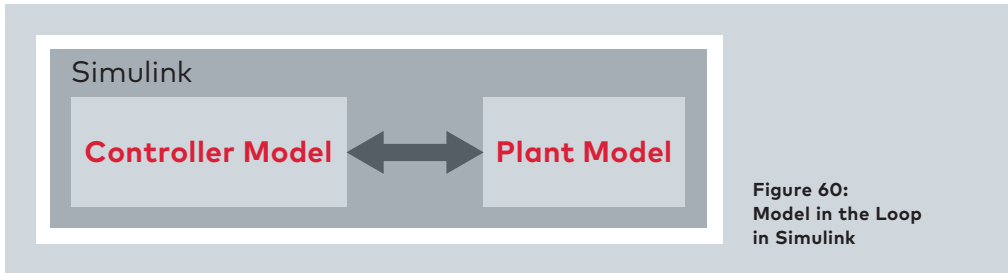

Figure 60:
Model in the Loop
in Simulink

In this development environment, both the controller and the plant are simulated as a model. In the example shown, both models run in Simulink as the runtime environment. The capabilities of the Simulink runtime environment are available to you for analyzing the behavior.

To realize the convenience of a measurement and calibration tool like CANape in an early development phase, an XCP Slave can be integrated in the controller model. In an authoring step, the Slave generates the A2L that matches the model and the user already has the full range of convenient operating features with visualization of process flows in graphic windows, access to characteristic curves and maps and much more.

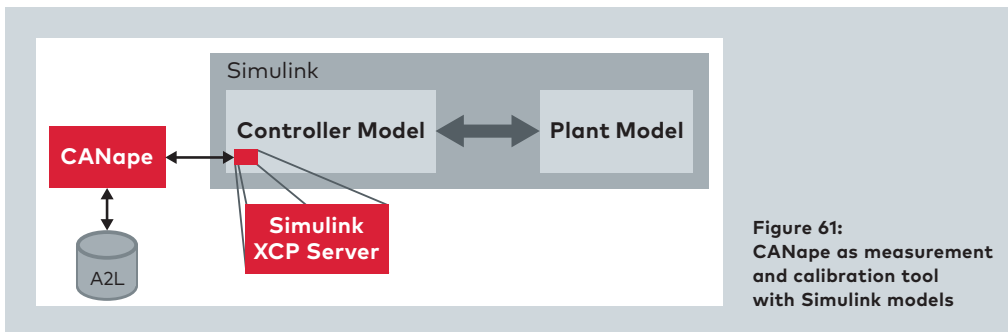

Figure 61:
CANape as measurement
and calibration tool
with Simulink models

Neither a code generation step nor instrumentation of the model is necessary for this. Time-stamps are also included with transmissions over XCP. CANape completely adapts to the time behavior of the Simulink runtime environment here. Whether the model is running faster or slower than in real time is of no consequence. For example, if the functional developer uses the Simulink Debugger in the model to step through the model, CANape still takes the time transmitted via XCP as the reference time.

4.2 Software in the Loop (SIL)

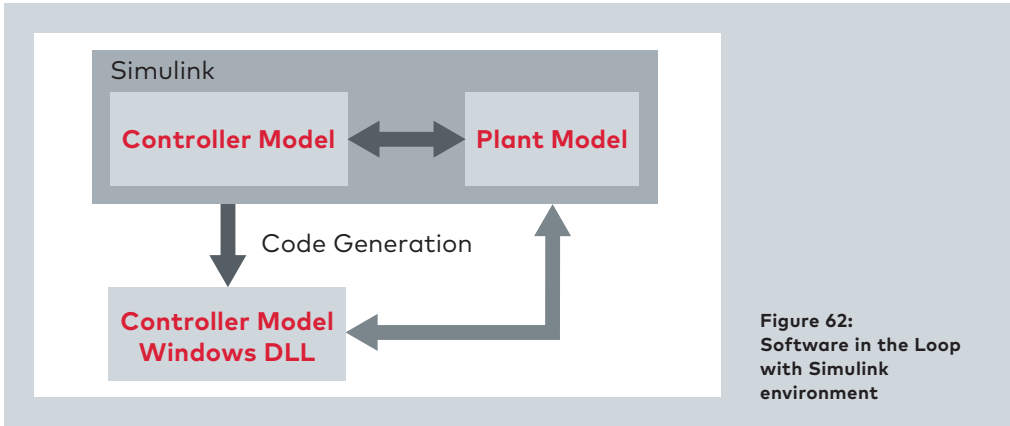

Figure 62:
Software in the Loop
with Simulink
environment

In this development step, code is generated from the model of the controller, which is then used in a PC-based runtime environment. Naturally, the controller may also have been developed without any sort of model-based approach. The plant continues to be simulated. XCP can be used to measure and calibrate the controller. If the controller originates from a Simulink model, a code generation step (Simulink Coder with the target "CANape") is used to generate the C code for a DLL and the associated A2L. If the Controller development is conducted based on manually written code, it is embedded in a C++ project that is delivered with CANape.

After compiling and linking, the DLL is used in the CANape context. With the support of the XCP connection, the algorithms in the DLL can be measured and calibrated exactly as if the application were already integrated in an ECU.

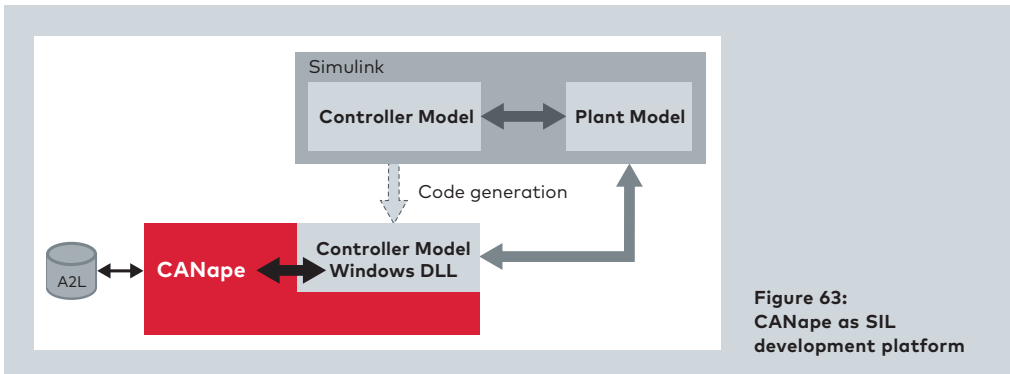
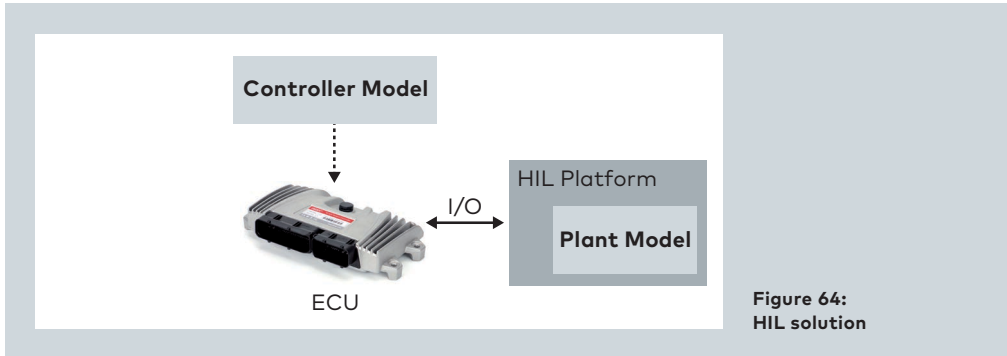

Figure 63:
CANape as SIL
development platform

4.3 Hardware in the Loop (HIL)

Many different kinds of HIL systems are available. They range from very simple, cost-effective systems all the way to very large and expensive expansion stages. The following figure shows the rough concept:



The controller algorithm runs in a microcontroller platform (e.g. the ECU), while the plant continues to be simulated. Depending on the parameters and the complexity of the plant and the necessary I/O, requirements of the HIL platform and the associated costs can rise steeply. Since the ECU runs in real time, the model of the plant must also be computed in real time.

To now introduce XCP for optimization appears trivial, because another ECU is being added. The whole system looks like this:

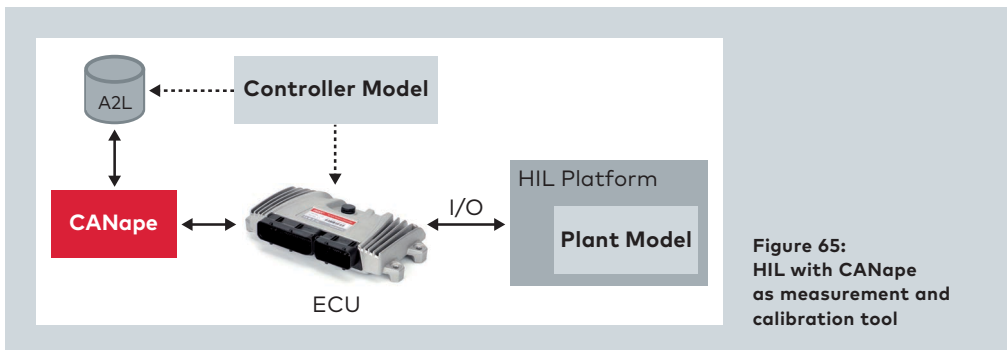

From CANape, the user has access to the algorithms in the ECU over XCP.

The Vector Tool CANoe is also used by many customers as a HIL system. With CANoe, a HIL system might look like this:

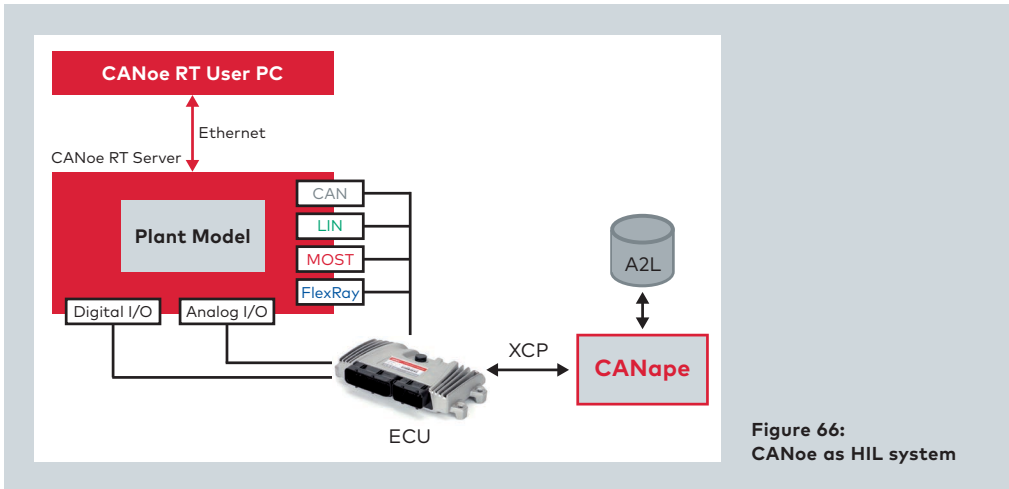

Figure 66:
CANoe as HIL system

The ability to access XCP data directly from CANoe for testing purposes results in the following variant as well:

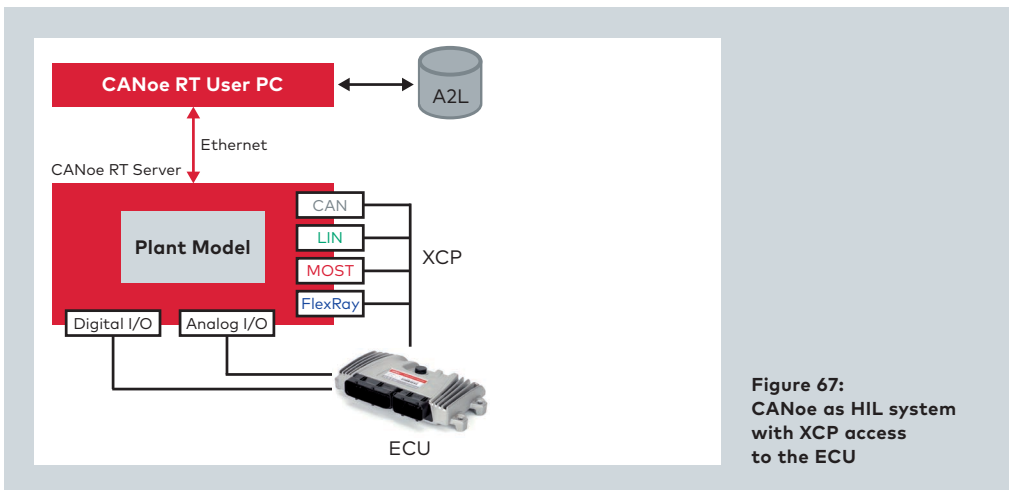
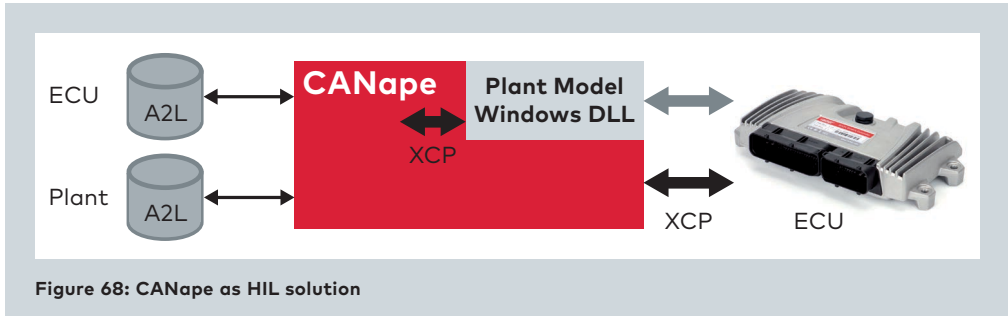

Figure 67:
CANoe as HIL system
with XCP access
to the ECU

Here the model of the plant runs on the CANoe real-time server. At the same time, XCP access to the ECU is also realized from CANoe. This gives a tool simultaneous access to the plant and the controller.

To round out the picture, yet another HIL solution option should be mentioned. The plant might also run as a DLL in CANape. This gives the user full access to the plant and to the controller over XCP.



4.4 Rapid Control Prototyping (RCP)

In this development phase, the control algorithm runs on real-time hardware instead of an ECU. This situation often occurs when the necessary ECU hardware is not yet available. Several platforms come in question as suitable hardware: from simple evaluation boards all the way to special automotive-level hardware solutions, depending on which additional requirements need to be fulfilled. Here too, integration with XCP helps in setting up an OEM-independent tool chain.

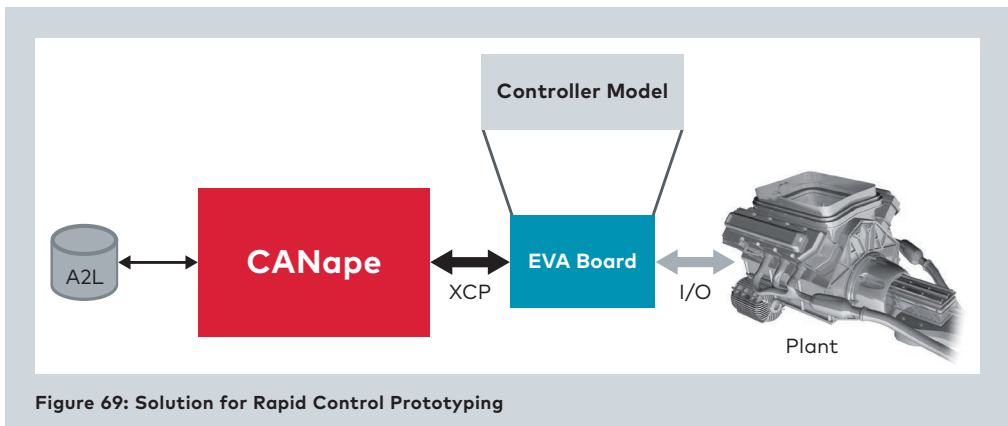

The concepts "Rapid" and "Prototyping" describe the task very well. The aim is to develop a functional prototype as quickly as possible, to use and test it in the runtime environment. This just requires simple work steps throughout the entire process.

In the literature, the RCP approach is frequently subdivided into two areas: fullpassing and bypassing.

As depicted in Figure 69, the entire controller runs on separate real-time hardware. This method is known as fullpassing, because the entire controller runs on the controller hardware. It must have the necessary I/O to be able to interface with the plant. Very often, it is only possible to fulfill technical requirements for the I/O with suitable power electronics.

It is not only the I/O that represents a challenge; often functional elements of the ECU software (e.g. network management) are needed to enable functionality in a more complex network. However, if a complete ECU is used for Rapid Control Prototyping instead of a general controller platform, the complexity of the flash process, the size of the overall software, etc. all work against the requirement for "rapid" development.

In summary: the use of an entire ECU as the runtime environment for the controller offers the advantage that the necessary hardware and software infrastructure for the plant exists. The disadvantage lies in the high degree of complexity. The concept of bypassing was developed to exploit the advantages of the ECU infrastructure without being burdened by the disadvantages of high complexity.

4.5 Bypassing

When bypassing occurs, data is recorded from the ECU and processed outside the ECU, and the result is written back to the ECU. As both measurement and writing to the ECU must occur in sync with the ECU processes, DAQ and STIM mechanisms are used. At least two DAQ lists are required, one with the DAQ direction (from Slave to Master) and one with the STIM direction (from Master to Slave).

In Figure 70, the ECU is connected to the plant. The necessary I/O and software components are available in the ECU. In the bypassing hardware, an algorithm A1 runs, which occurs in Version A of the ECU. A1 is a new variant of the algorithm and should now be tried out on the real plant.

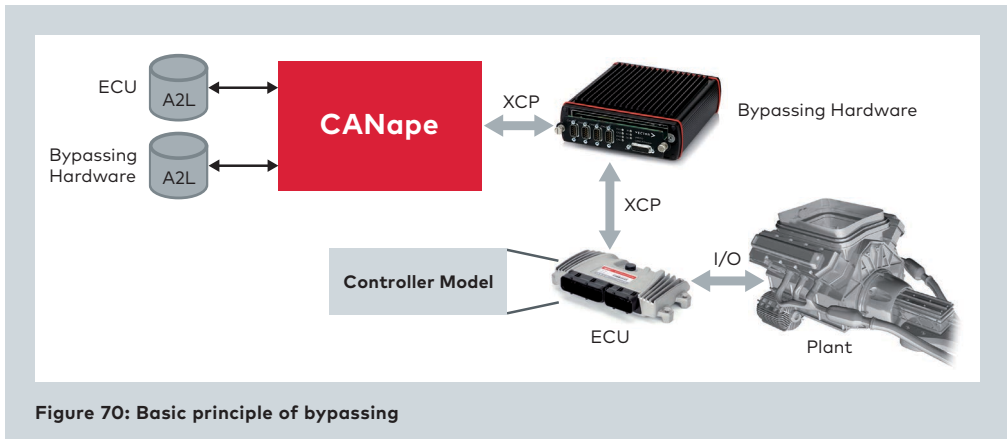

The bypassing hardware (a VN8900 device in the figure) and the ECU are interconnected over XCP. One goal here is to get the data needed for algorithm A1 from the ECU by DAQ; another goal is to stimulate the results of A1 back into the ECU. The following figure illustrates the schematic flow:

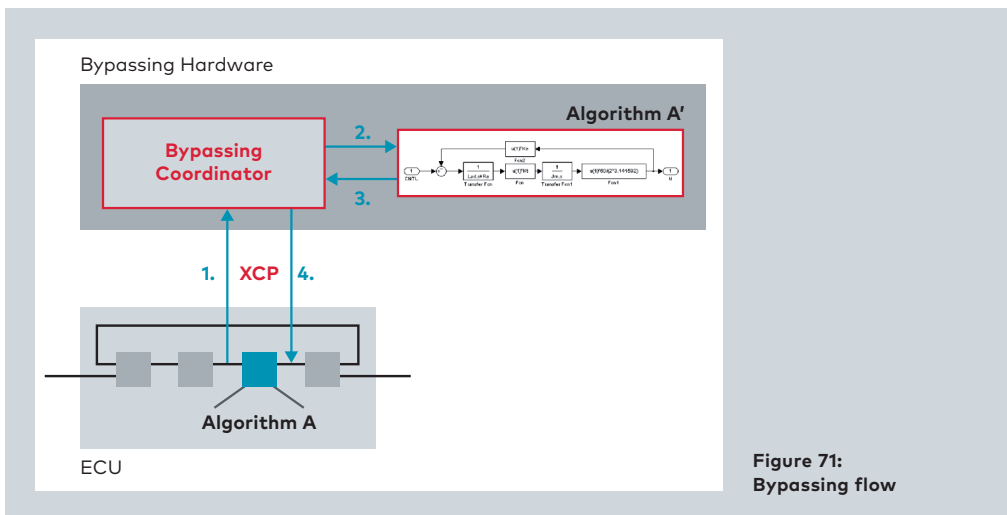

Depicted in the ECU is a blue function block in which the algorithm A runs. To ensure that A1 can now be used, the data enters algorithm A as an input variable and it is measured from the ECU by DAQ.

Step 1: In the ECU, the data is recorded and sent to the bypassing tool before the original function is calculated in the ECU. Normally, the input data in functions A and A1 is are identical.

Step 2: The data transferred via DAQ is now transferred to algorithm A1.

Step 3: The results of the calculation of algorithm A1 are transferred to the bypassing tool.

Step 4: The data is transferred into the ECU via STIM. The ECU calculates algorithm A during this time. If the stimulated results are available and calculation of algorithm A is com-

plete, the values calculated in the ECU are typically overwritten by the stimulated values of algorithm A1.

This makes it possible to use the value computed by algorithm A1 and not from A in the ECU's overall control process. This method permits using a combination of the rapid substitution of algorithms on the bypassing hardware that incorporates the I/O and the ECU's basic software.

Of course, performance limits of the transport protocol also affect bypassing. If short bypassing times are needed, access to the ECU by DAQ and STIM may also be performed via the controller's debugging or trace interfaces. The Vector VX1000 measurement and calibration hardware converts the data into an XCP-on-Ethernet data stream from the controller interface. In this process, up to one megabyte of data can be transported into the ECU.

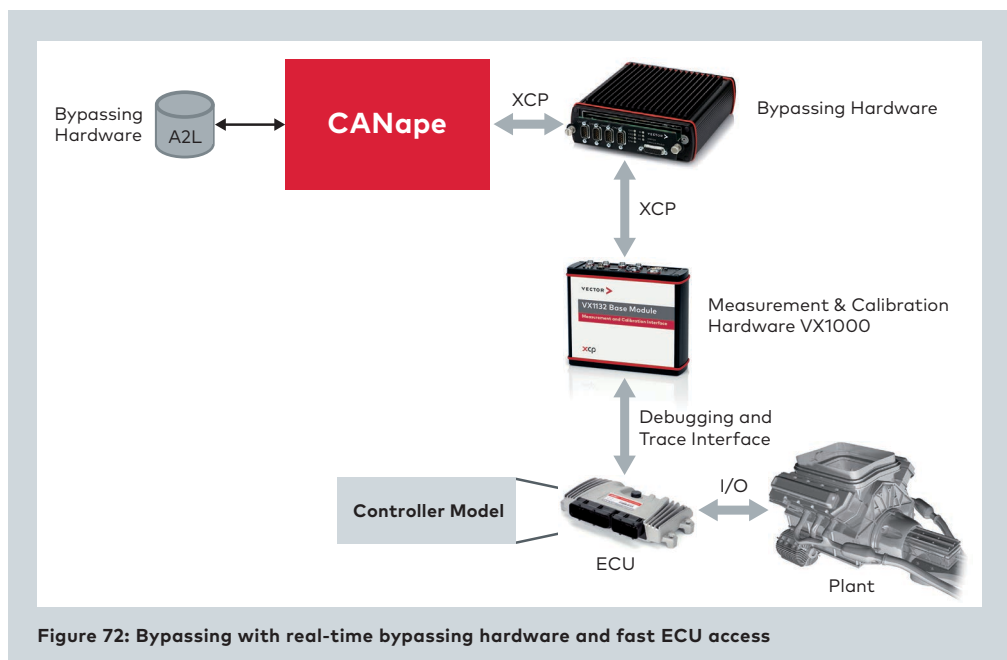

In the figure, ECU access occurs via XCP on Ethernet, and calculation of the bypass algorithm occurs on separate bypassing hardware (VN8900 network interface) with a real-time operating system. This means that the variance of the calculation time is considerably smaller than with calculation on a laptop, as the processing time is not affected by other applications.

4.6 Shortening Iteration Cycles with Virtual ECUs

Stimulation with data is necessary to optimize the algorithm in the ECU with the help of XCP. This can be done in the ECU in the framework of test drives. But there is yet another solution that is available with XCP, in which the algorithm does not run on an ECU; rather it runs on the PC in the form of executable code or as a model in Simulink in the form of a "virtual ECU." This virtual ECU does not need to run in real time, because in this case no connection to a real system exists. It can run significantly faster – depending on the PC's computing power.

The algorithm is stimulated by a previously logged measurement file, which contains all signals that are needed as input signals for the algorithm. The connection to CANape is set up over XCP. The user can perform the parameterization and measurement configuration. Afterwards, execution is started. Here the data from the test drive is fed into the algorithm as stimulation and the desired measurement parameters from the application are simultaneously measured out and saved to a measurement file.

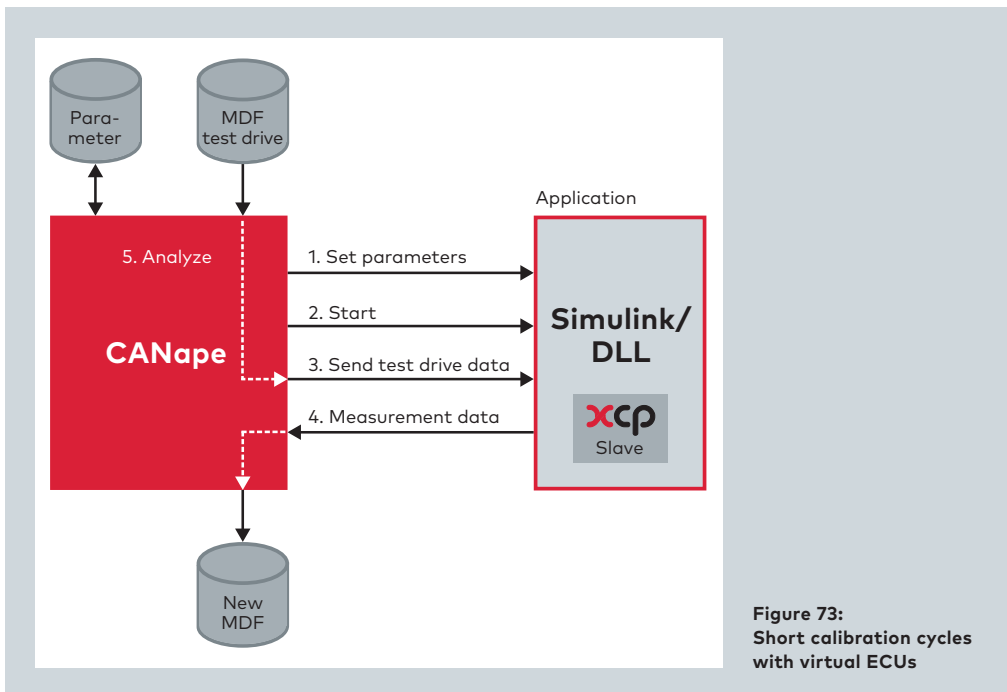
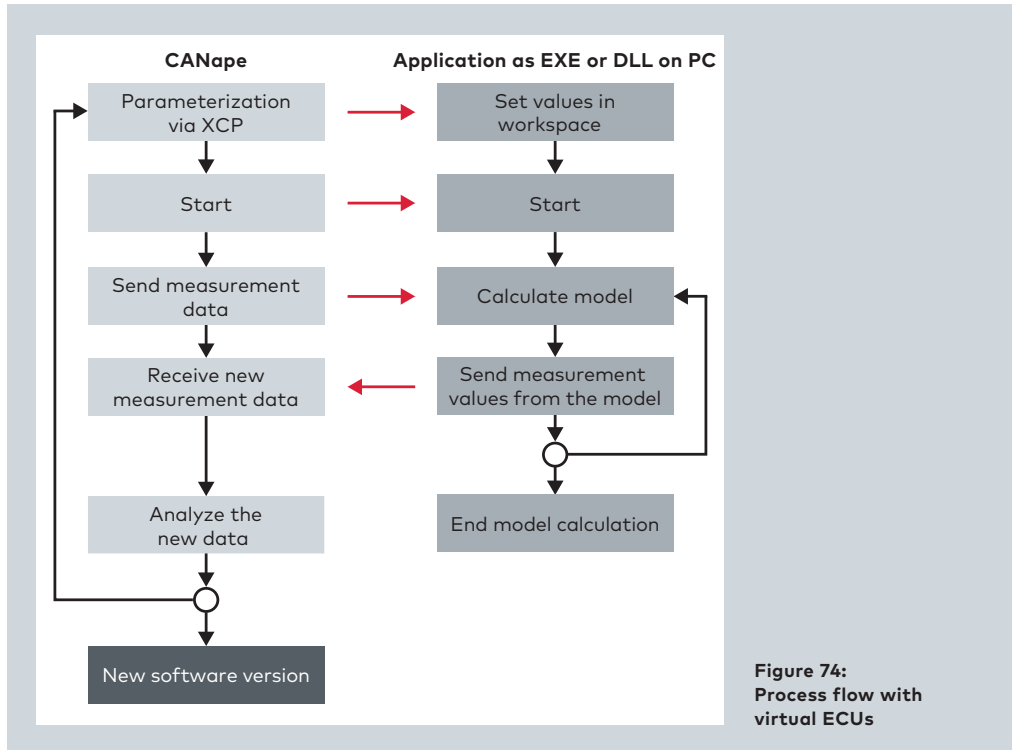

Figure 73:
Short calibration cycles
with virtual ECUs

After the calculation has been completed, a new measurement file is available to the user for analysis of ECU behavior. The length of time of the new measurement file precisely matches the length of the input measurement file. If the duration of a test drive is one hour, the algorithm on the PC might calculate the entire test drive in just a few seconds. Then a measurement result exists, which corresponds to a test of one hour duration. Based on the data analysis, the user makes decisions about parameterization and the iteration cycle is repeated.



To shorten the iteration cycles, the algorithm is always stimulated with the same data. That makes the results with different parameters much more comparable, because the results are only influenced by the parameters that differ.

This process can of course be automated. The integrated script language of CANape performs an analysis of the measurement results, from which parameter calibration settings are derived and automatically executed. It is also possible to have the process controlled by an external optimization tool such as MATLAB over the CANape automation interface.

5 Example of an XCP Implementation

To make it possible for an ECU to communicate over XCP, it is necessary to integrate an XCP driver in the ECU's application. The example described below is of the XCP driver which you can download free of charge at the Download Center of the Vector website (www.vector.com/xcp-driver). This packet also contains some sample implementations for various transport layers and target platforms. The driver consists of the protocol-Layer with the basic functionality needed for measurement and calibration. It does not include features such as Cold Start Measurement, Stimulation or flashing. You can purchase a full implementation as a product that is integrated in the Vector CANbedded or AUTOSAR environment.

The XCP protocol layer is placed over the XCP transport layer, which in turn is based on the actual bus communication. The implementation of the XCP protocol layer only consists of a single C file and a few H files (`xcpBasix.c`, `xcpBasic.h`, `xcp_def.h` and `xcp_cfg.h`). The examples include implementations for various transport layers, e.g. Ethernet and RS232. In the case of CAN, the transport layer is normally very simple and the various XCP message types are mapped directly to CAN messages. There are then separate fixed identifiers for the Tx and Rx directions.

The software interface between the transport and protocol layers is very simple. It contains just a few functions:

- > When the Slave receives an XCP message over the bus, it first arrives in the communication driver, which routes the message to the XCP transport layer. The transport layer informs the protocol layer about the message with the function call `XcpCommand()`.
- > If the XCP protocol layer wishes to send a message (e.g. a response to an XCP command from the Master or a DAQ message), the message is routed to the transport layer by a call of the `ApplXcpSend()` function.
- > The transport layer informs the protocol layer that the message was successfully sent by the function call `XcpSendCallBack()`.

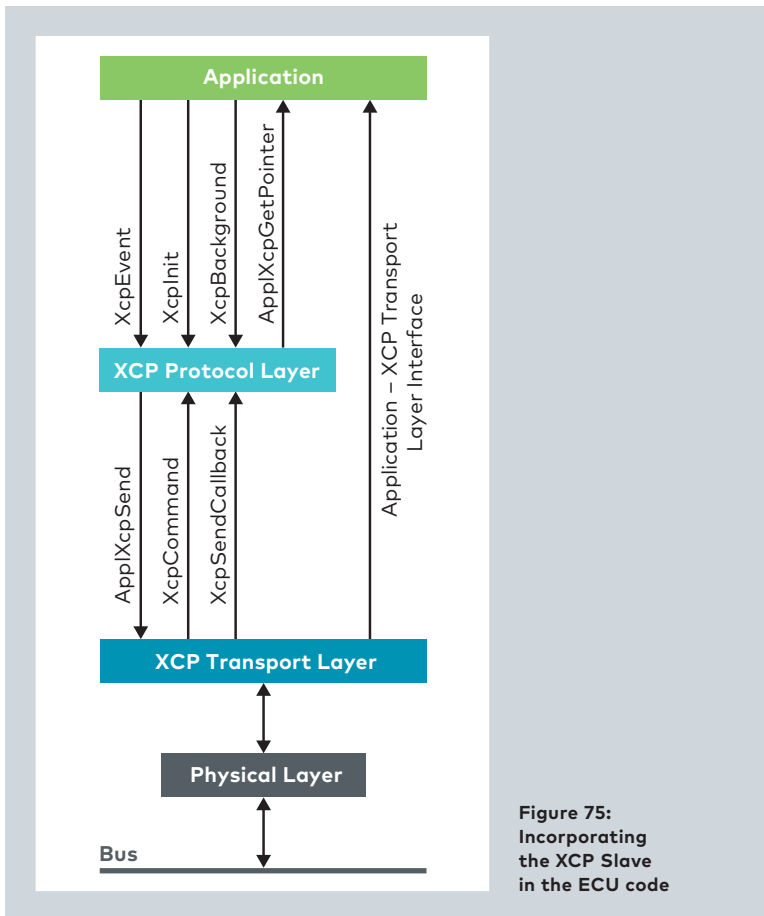

Figure 75:
Incorporating
the XCP Slave
in the ECU code

The interface between the application and the protocol layer can only be implemented via four functions:

- > The application activates the XCP driver with the help of `XcpInit()`. This call is made once in the starting process.
- > With `XcpEvent()`, the application informs the XCP driver that a certain event has occurred (e.g. "End of a computational cycle reached").
- > The call `XcpBackground()` lets the XCP driver execute certain activities in background (e.g. calculation of a checksum).
- > Since the addresses in A2L files are always defined as 40-bit values (32-bit address, 8-bit address extension), the XCP driver uses the function `ApplXcpGetPointer()` to obtain a pointer from a A2L-conformant address.

These interfaces are sufficient to integrate basic functionalities for measurement and calibration. Other interfaces are only needed for extended functions such as page switching, identification or seed & key. They are described in detail in documentation for the driver.

5.1 Description of Functions

void XcpInit (void)

Task:

Initialize the XCP driver.

Description:

The application activates the XCP driver with XcpInit(). This command must be executed exactly once before any sort of XCP driver function may be called.

void XcpEvent (BYTE event)

Task:

The application informs the XCP driver about which event occurred. A unique event number is assigned to each event here.

Description:

In setting up the measurement configuration in the measurement and calibration tool, the user selects which measured values should be synchronously acquired with which events. The information on measured values and events originates from the A2L. The desired measurement configuration is communicated to the XCP driver in the form of DAQ lists.

Example of an event definition in an engine controller:

```
XcpEvent (1);    // Event 1 stands for the 10-ms task
XcpEvent (2);    // Event 2 stands for the 100-ms task
XcpEvent (5);    // Event 5 stands for the 1-ms task
XcpEvent (8);    // Event 8 is used for ignition angle synchronous measurements
```

BYTE XcpBackground (void)

Task:

Execute background activities of the XCP driver.

Description:

This function should be called periodically in a background or idle task. It is used by the XCP driver, for example, to compute the checksum, because the computation of a longer checksum in XcpCommand() could take an unacceptably long time. With each call of XcpBackground(), a partial checksum of 256 bytes is computed. The duration of a checksum computation therefore depends on the call frequency of XcpBackground(). There are no other requirements for the call frequency or periodicity. The return value 1 indicates that a checksum computation is currently running.

void XcpCommand (DWORD* pCommand)

Task:

Interpret an XCP command.

Description:

This function must be called each time the transport layer receives a XCP frame. The parameter is a pointer to the frame.

void ApplXcpSend (BYTE len, BYTE *msg)

Task:

Transfer a frame to be sent to the transport layer.

Description:

With this call, the protocol layer sends a message to the transport layer for transmission to the Master. The call XcpSendCallBack implements a handshake method between the protocol and transport layers.

BYTE XcpSendCallBack (void)

Task:

The protocol layer uses this callback to inform the transport layer that the last message that was transferred to ApplXcpSend() was successfully transmitted.

Description:

The protocol layer does not call an ApplXcpSend() command until XcpSendCallBack() indicates that the prior message was successfully transmitted. XcpSendCallBack() returns the value 0 (FALSE) if the XCP driver is in idle. If there are more frames to be sent, ApplXcpSend() is called directly from XcpSendCallBack().

BYTE *ApplXcpGetPointer (BYTE addr_ext, DWORD addr)

Task:

Convert an A2L-conformant address to a pointer.

Description:

The function maps the 40-bit A2L-conformant addressing (32-bit address + 8-bit address extension) that is sent by the XCP Master to a valid pointer. The address extension can be used, for example, to distinguish different address areas or memory types.

5.2 Parameterization of the Driver

In many respects, the XCP driver is scalable and parameterizable to properly handle the wide variety of functional content, transport protocols and target platforms. All settings are made in the parameter file `xcp_cfg.h`. In the simplest case, they appear as follows:

```
/* Define protocol parameters */
#define kXcpMaxCTO 8 /* Maximum CTO Message Length */
#define kXcpMaxDTO 8 /* Maximum DTO Message Length */
#define C_CPUATYPE_BIGENDIAN /* byte order Motorola */

/* Enable memory checksum */
#define XCP_ENABLE_CHECKSUM
#define kXcpChecksumMethod XCP_CHECKSUM_TYPE_ADD14

/* Enable calibration */
#define XCP_ENABLE_CALIBRATION
#define XCP_ENABLE_SHORT_UPLOAD

/* Enable data acquisition */
#define XCP_ENABLE_DAQ
#define kXcpDaqMemSize (512) /* Memory space reserved for DAQ */
#define XCP_ENABLE_SEND_QUEUE
```

For a CAN transport layer, the appropriate CTO and DTO parameters of eight bytes are set. The driver must know whether it is running on a platform with Motorola or Intel byte order, in this case a Motorola-CPU (Big Endian). The remaining parameters activate the functionalities: measurement, calibration and checksum computation. The algorithm for checksum computation is configured (here summing of all bytes into a DWORD) and the parameter of the available memory is indicated for the measurement (here 512 bytes). The memory is primarily needed to store the DAQ lists and to buffer the data during the measurement. The parameter therefore determines the maximum possible number of measurement signals. In the driver documentation you will find more detailed information on estimating the necessary parameters.

6 Protocol Development Overview

The following overview shows some of the essential developments of the XCP protocol, which was standardized in 2003.

6.1. XCP Version 1.1 (2008)

- > Description of the same XCP interface using two different physical interfaces within the same A2L (e.g. "XCP on Vehicle CAN" and "XCP on Calibration CAN")
- > The new command `WRITE_DAQ_MULTIPLE` makes it possible to accelerate configuration of the Slave. Two ODTs appearing in succession in a DAQ list can be communicated in a single step.
- > High time synchronization via "TIMESTAMP_EVENT." Timestamp information is communicated by the Slave. The trigger can be initiated via an external synchronization cable.
- > Compression of embedded A2L files

All expansions are optional. XCP 1.1 is thus compatible with XCP 1.0.

6.2. XCP Version 1.2 (2013)

- > Parameters in the A2L for the definition of the required ECU resources via XCP-DAQ measurement configurations (e.g. RAM usage, CPU execution time and required transfer bandwidth for CAN or Ethernet). The XCP Master can access the parameters, calculate resource usage for the measurement and warn the user if overshooting occurs.
- > Prioritization control by the Master for transfer of the measurement data via CAN. The objective here is to not disturb the necessary communication flow of the vehicle CAN to the greatest degree possible.
- > Calculation of the required bandwidth and limits for the transfer of data via TCP or UDP
- > Description of XCP on CAN FD

All expansions are optional. XCP 1.2 is thus compatible with XCP 1.1.

6.3. XCP Version 1.3 (2015)

- > Improvement of the time correlation of XCP Slaves using multicast solutions found on the same network
- > Time synchronization between XCP Slave timestamp and external clock, e.g. via IEEE 1588
- > Checking of the bypassing data flow and error handling

All expansions are optional. XCP 1.3 is thus compatible with XCP 1.2.

The Authors



Andreas Patzer

Mr. Patzer graduated in Electrical Engineering from the Technical University of Karlsruhe. In his studies he specialized in measurement and control engineering and information and industrial engineering. In 2003, he joined Vector Informatik GmbH in Stuttgart. Andreas Patzer has supported XCP projects from the very start, since XCP was standardized by ASAM e.V. in the same year he was hired. He currently manages the Customer Relations and Services area as a team leader for the Measurement & Calibration product line.

**Rainer Zaiser**

Mr. Zaiser has a degree in Electrical Engineering from the University of Stuttgart. After graduating, he came directly to Vector Informatik GmbH in autumn 1988, where he has helped to create many of the standards that have become established in the automotive industry such as DBC, MDF, CCP, A2L and to a large extent XCP. From the start, he headed up the Measurement & Calibration and Network Interfaces product lines.

Table of Abbreviations and Acronyms

A2L	File extension for an ASAM 2MC language file
AML	ASAM 2 Meta Language
ASAM	Association for Standardisation of Automation and Measuring Systems
BYP	Bypassing
CAL	Calibration
CAN	Controller Area Network
CCP	CAN Calibration Protocol
CMD	Command
CS	Checksum
CTO	Command Transfer Object
CTR	Counter
DAQ	Data Acquisition, Data Acquisition Packet
DTO	Data Transfer Object
ECU	Electronic Control Unit
ERR	Error Packet
EV	Event Packet
FIBEX	Field Bus Exchange Format
LEN	Length
MCD	Measurement Calibration and Diagnostics
MTA	Memory Transfer Address
ODT	Object Descriptor Table
PAG	Paging
PGM	Programming
PHY	Physical Layer respectively description of the chip connecting a link layer device to a physical medium, for example Ethernet PHY
PID	Packet Identifier
PTP	Precision Time Protocol
RES	Command Response Packet
SERV	Service Request Packet
SPI	Serial Peripheral Interface
STD	Standard
STIM	Data Stimulation Packet
TCP/IP	Transfer Control Protocol/Internet Protocol
TS	Timestamp
UDP/IP	Unified Data Protocol/Internet Protocol
USB	Universal Serial Bus
XCP	Universal Measurement and Calibration Protocol
Download	Sending of data from Master to Slave
Upload	Sending of data from Slave to Master

Literature

XCP is specified by ASAM (Association for Standardisation of Automation and Measuring Systems).

You will find details on the protocol and on ASAM at: **www.asam.net**

Web Addresses

Standardization committees:

> ASAM, XCP protocol-specific documents, A2L specification, **www.asam.net**

Supplier of development software:

> MathWorks, information on MATLAB, Simulink and Simulink Coder, **www.mathworks.com**

> Vector Informatik GmbH, demo version of CANape, free of charge and openly available XCP driver (basic version), comprehensive information on the topics of ECU calibration, testing and simulation, **www.vector.com**

Table of Figures

Figure 1: Fundamental communication with a runtime environment.....	8
Figure 2: The Interface Model of ASAM.....	9
Figure 3: An XCP Master can simultaneously communicate with multiple Slaves.....	10
Figure 4: Subdivision of the XCP protocol into protocol layer and transport layer	14
Figure 5: XCP Slaves can be used in many different runtime environments	15
Figure 6: XCP packet.....	19
Figure 7: Overview of XCP Packet Identifier (PID)	19
Figure 8: XCP communication model with CTO/DTO	20
Figure 9: Message identification	21
Figure 10: Timestamp	21
Figure 11: Data field in the XCP packet.....	22
Figure 12: The three modes of the XCP protocol: Standard, Block and Interleaved mode...24	
Figure 13: Overview of the CTO packet structure	25
Figure 14: Trace example from a calibration process.....	30
Figure 15: Transfer of a parameter set file to an ECU's RAM	31
Figure 16: Hex window	32
Figure 17: Address information of the parameter "Triangle" from the A2L file	33
Figure 18: Polling communication in the CANape Trace window	34
Figure 19: Events in the ECU	35
Figure 20: Event definition in an A2L.....	35
Figure 21: Allocation of "Triangle" to possible events in the A2L.....	36
Figure 22: Selecting events (measurement mode) for each measurement parameter.....	36
Figure 23: Excerpt from the CANape Trace window of a DAQ measurement.....	37
Figure 24: ODT: Allocation of RAM addresses to DAQ DTO.....	38
Figure 25: DAQ list with three ODTs.....	39
Figure 26: Static DAQ lists	40
Figure 27: Dynamic DAQ lists	41
Figure 28: Event for DAQ and STIM	42
Figure 29: Structure of the XCP packet for DTO transmissions.....	43
Figure 30: Identification field with absolute ODT numbers.....	44
Figure 31: ID field with relative ODT and absolute DAQ numbers (one byte)	44
Figure 32: ID field with relative ODT and absolute DAQ numbers (two bytes)	44
Figure 33: ID field with relative ODT and absolute DAQ numbers as well as fill byte (total of four bytes).....	45
Figure 34: XCP Slave with free-running clock	46
Figure 35: The clock of the XCP Slave is synchronized with the grandmaster clock	47
Figure 36: Definition of which bus nodes send which messages.....	49
Figure 37: Representation of a CAN network.....	50
Figure 38: Example of XCP-on-CAN communication.....	51
Figure 39: Representation of an XCP-on-CAN message.....	51
Figure 40: Illustration of a CAN FD frame.....	52
Figure 41: Nodes K and L are redundantly interconnected.....	54
Figure 42: Communication by slot definition	54
Figure 43: Representation of a FlexRay communication matrix.....	55
Figure 44: Representation of the FlexRay LPDUs	56

Figure 45: Allocation of XCP communication to LPDUs.....	57
Figure 46: XCP packet with TCP/IP or UDP/IP	58
Figure 47: XCP-on-Sxl packet	59
Figure 48: Memory representation	61
Figure 49: Representation of driver settings for the flash area	63
Figure 50: Representation of the block transfer mode.....	66
Figure 51: Parameters in a calibration window.....	72
Figure 52: Signal response over time	72
Figure 53: Initial parameter setting in RAM	82
Figure 54: Initial situation after booting	86
Figure 55: Pointer change and copying to RAM	87
Figure 56: Pointer table for individual parameters.....	87
Figure 57: Double pointer concept.....	89
Figure 58: Application areas and application cases	92
Figure 59: Plants and controllers	92
Figure 60: Model in the Loop in Simulink	93
Figure 61: CANape as measurement and calibration tool with Simulink models	93
Figure 62: Software in the Loop with Simulink environment.....	94
Figure 63: CANape as SIL development platform	94
Figure 64: HIL solution.....	95
Figure 65: HIL with CANape as measurement and calibration tool.....	95
Figure 66: CANoe as HIL system.....	96
Figure 67: CANoe as HIL system with XCP access to the ECU	96
Figure 68: CANape as HIL solution.....	97
Figure 69: RCP solution	97
Figure 70: Basic principle of bypassing.....	99
Figure 71: Bypassing flow	99
Figure 72: Bypassing with real-time bypassing hardware and fast ECU access	100
Figure 73: Short calibration cycles with virtual ECUs.....	101
Figure 74: Process flow with virtual ECUs.....	102
Figure 75: Incorporating the XCP Slave in the ECU code	107

Appendix – XCP Solutions at Vector

Vector made a significant effort in giving shape to the XCP standard. Its extensive know-how and vast experience were utilized to provide comprehensive XCP support:

Tools

- > The primary use area of **CANape** is in optimal parameterization (calibration) of electronic control units (ECUs). During the system's runtime, you calibrate parameter values and simultaneously acquire measured signals. The physical interface between CANape and the ECU is over XCP (for all standardized transport protocols) or CCP.
- > Complete tool chain for generating and managing the necessary A2L description files (**ASAP2 Tool-Set** and **CANape** with the **ASAP2 Editor**).
- > You use **CANoe.XCP** to access internal ECU values for testing and analysis tasks.

ECU Interfaces

The **VX1000** measurement and calibration hardware offers the option of equipping ECUs with an XCP-on-Ethernet interface. This involves connecting a Plug on Device (POD) to the ECU for direct access to the controller, e.g. over DAP, JTAG, Nexus, etc. The POD transmits the data to a base module, which operates as an XCP Slave and provides the data to the XCP Master on the PC over XCP on Ethernet. This makes it unnecessary to have an XCP Slave in the ECU. The user benefits from a high measurement data throughput rate of up to 50 MByte/s and short measurement intervals of less than 15 μ s.

Embedded Software

Communication modules with separate transport layers for CAN, FlexRay and Ethernet:

- > **XCP Basic** – free download at www.vector.com/xcp-driver, only contains basic XCP functions. Configuration of the XCP protocol and modification of the transport layer are performed manually in the source code. You need to integrate XCP Basic in your project yourself.
- > **XCP Professional** – contains useful extensions to the ASAM specification and enables tool-based configuration. Available for Vector CANbedded basic software.
- > **MICROSAR XCP** – contains the functional features of XCP Professional and is based on AUTOSAR specifications. Available for Vector MICROSAR basic software.

Services

- > **Consultation** for using XCP in your projects
- > **Integration** of XCP in your ECU

Training

- > You can learn about the underlying mechanisms and models of the protocol in the "**XCP Fundamentals Seminar**".
- > In the "**CANape with XCP on FlexRay Workshop**" you learn about FlexRay fundamentals and the special aspects of XCP on FlexRay are explained, in particular dynamic bandwidth management.

Special XCP Support by CANape

CANape was the first MCD tool to support the XCP 1.0 specification and was also the first XCP on FlexRay Master on the market.

A special technical feature of XCP on FlexRay is dynamic bandwidth management. Here, CANape identifies the available bandwidth provided for XCP in the FlexRay ClusterP and it allocates this bandwidth to the momentary application data traffic dynamically and very efficiently. The available bandwidth is thereby optimally used for XCP communication.

Moreover, CANape has a DLL interface. It enables support of XCP on any desired (user-defined) transport layer. This lets you integrate any desired test instrumentation or proprietary protocols in CANape. A code generator supports you in creating the XCP-specific share of such a driver.

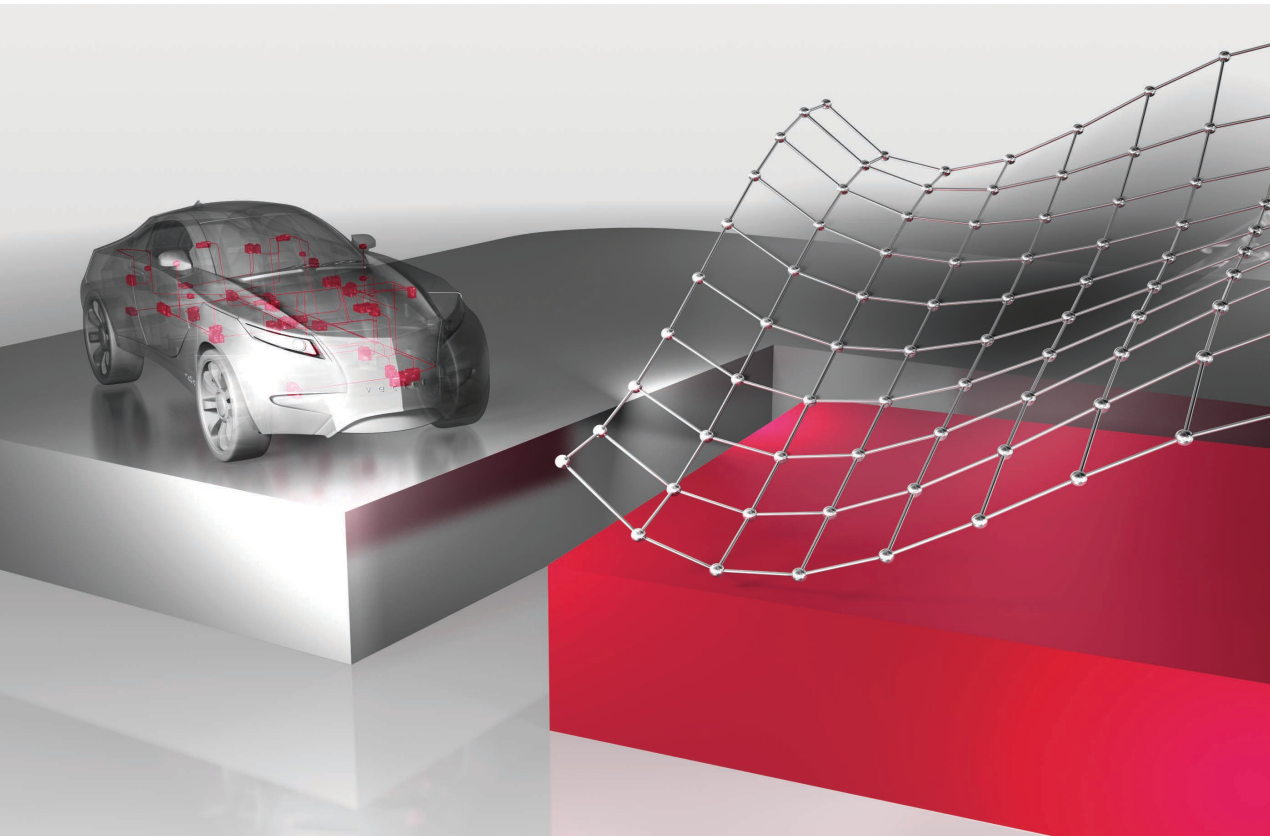

Index

A

A2L 9, 10, 25, 35, 40, 42, 56, 57, 62, 63, 68,
71 – 76, 94, 108, 109, 116
Address extension 29, 33, 38, 107, 109
AML 25, 74, 116
ASAM 7 – 9, 60, 116
ASAP2 Tool-Set 76

B

Bandwidth optimization 34
Bus load 34
BYP 116
Bypassing 45, 98, 100

C

CAN 7, 8, 14, 24, 29, 33, 38, 49, 50, 51, 55,
75, 116
CAN FD 52
CCP 7, 8, 40, 49, 116
CMD 25, 56, 116
CTO 21, 22, 25, 116
CTR 58, 59, 116
CYCLE_REPETITION 56

D

DAQ 22, 32 – 45, 65, 67, 77, 99, 100, 106,
108, 116
DAQ_KEY_BYTE 45
DBC 49
Double Pointer Concept 88
DOWNLOAD 30, 31, 66
DTO 21, 22, 33, 37, 116

E

ECU 9, 74, 98, 99, 116
ECU description file A2L 72 – 77
EEPROM 16, 31, 67
ERR 25, 28, 116
Ethernet 57 – 59
EV 29, 116
Event 35, 38 – 40, 42, 65, 67, 77, 108

F

FIBEX 55 – 57
Flash memory 16, 17, 61 – 64, 67
FLX_CHANNEL 56
FLX_LPDU_ID 56
FLX_SLOT_ID 56
Fullpassing 98

G

GET_CAL_PAGE 25, 62
GET_DAQ_EVENT_INFO 65, 77
GET_DAQ_LIST_INFO 77
GET_DAQ_PROCESSOR_INFO 45, 65, 77
GET_DAQ_RESOLUTION_INFO 65, 77
Grandmaster clock 47, 48

H

HIL 92, 95 – 97

I

IEEE 1588 47
IF_DATA 25

K

Commands 25
Compile 76, 80, 82, 94

L

Linking 80, 94
LPDU 56

M

Maturity level 31
MIL 93
MTA 30, 116
Multicast 46, 113

O

ODT 37 – 41, 43, 44, 65, 77, 116
OFFSET 56

P

PAG	116
Page	61 – 63
Page switching	62, 63
Parameter	85
PGM	116
PID	8, 19, 21, 25, 43, 116
Polling	33, 34, 36
PTP	47

R

RAM	16 – 18, 30, 31, 37, 39, 63, 67, 80, 82, 85, 86, 88
Reboot	32
RES	21, 28, 56, 116

S

Sector	61 – 63
Segment	61 – 63
SEGMENT_NUMBER	62
SERV	29, 116
SET_CAL_PAGE	25, 62
SET_MTA	30
SHORT_UPLOAD	30, 33, 66
SIL	92, 94
Single Pointer Concept	86
STIM	33, 42, 43, 45, 65, 77, 100, 116
Stimulation	29, 68, 101

T

Task	108
TCP/IP	57, 58, 116

U

UDP/IP	57, 58, 116
USB	60, 116

V

Virtual ECU	101
Volatile	81, 82
VX1000	100



Get More Information

Visit our Website for:

- > News
- > Products
- > Demo Software
- > Support
- > Trainings Classes
- > Addresses

www.vector.com